

This article was downloaded by: [Romanian Ministry Consortium]

On: 20 May 2010

Access details: Access Details: [subscription number 918910071]

Publisher Taylor & Francis

Informa Ltd Registered in England and Wales Registered Number: 1072954 Registered office: Mortimer House, 37-41 Mortimer Street, London W1T 3JH, UK



Journal of Natural History

Publication details, including instructions for authors and subscription information:

<http://www.informaworld.com/smpp/title~content=t713192031>

The jumping plant-lice (Hemiptera, Psylloidea) associated with Schinus (Anacardiaceae): systematics, biogeography and host plant relationships

D. Burckhardt ;Y. Basset

To cite this Article Burckhardt, D. and Basset, Y. (2000) 'The jumping plant-lice (Hemiptera, Psylloidea) associated with Schinus (Anacardiaceae): systematics, biogeography and host plant relationships', *Journal of Natural History*, 34: 1, 57 – 155

To link to this Article: DOI: 10.1080/002229300299688

URL: <http://dx.doi.org/10.1080/002229300299688>

PLEASE SCROLL DOWN FOR ARTICLE

Full terms and conditions of use: <http://www.informaworld.com/terms-and-conditions-of-access.pdf>

This article may be used for research, teaching and private study purposes. Any substantial or systematic reproduction, re-distribution, re-selling, loan or sub-licensing, systematic supply or distribution in any form to anyone is expressly forbidden.

The publisher does not give any warranty express or implied or make any representation that the contents will be complete or accurate or up to date. The accuracy of any instructions, formulae and drug doses should be independently verified with primary sources. The publisher shall not be liable for any loss, actions, claims, proceedings, demand or costs or damages whatsoever or howsoever caused arising directly or indirectly in connection with or arising out of the use of this material.

The jumping plant-lice (Hemiptera, Psylloidea) associated with *Schinus* (Anacardiaceae): systematics, biogeography and host plant relationships

D. BURCKHARDT† and Y. BASSET‡

† *Naturhistorisches Museum, Augustinergasse 2, CH-4001 Basel, Switzerland; email: BurckhardtD@ubaclu.unibas.ch*

‡ *Smithsonian Tropical Research Institute, Apartado 2072, Balboa, Ancon, Panama; email: bassety@tivoli.si.edu*

(Accepted 26 November 1998)

The gall-forming psylloid fauna associated with the temperate Neotropical plant genus *Schinus* (Anacardiaceae) is revised, and keys are provided for adults, larvae and galls. Fourteen species are recognized in the genus *Calophya* (Calophyidae), 10 of which are described as new; *C. gallifex* and *C. schini* are reinstated from former synonymy with *C. rubra*. An additional closely related new species, *C. clavuligera* sp. n., is described from *Lithrea* spp. In the genus *Tainarys* (Psyllidae, Rhinocolinae), six species are recognized and, for five of these, *Schinus* species are confirmed hosts. Two of them are described as new and one is recombined from *Leurolophus*. A new *Leurolophus* species is described from *Lithrea molleoides*. Based on a cladistic analysis *Pelmatobranchia*, *Microceropsylla* and *Neocalophya* are synonymized with *Calophya*, producing five new and one revised species combinations as well as one nomen nov. A list of the 59 currently recognized species is provided with information on synonymy, distribution and host plants. The cladistic analyses suggest that the *Schinus* inhabiting calophyids form two monophyletic groups, the *C. rubra* and *C. hermicitae* groups, respectively. A discriminant analysis of 15 variables for both males and females provides morphometric characters for separating the morphologically very homogenous adults of the *C. rubra* group. The phylogenetic relationships of the Rhinocolinae are re-evaluated, and the genera *Tainarys* and *Leurolophus* are redefined. *Notophyllura* is transferred from the Euphyllurinae to the Rhinocolinae. *Tainarys* forms the sister group of *Leurolophus* + *Notophyllura*. Based on mapped distributions four areas of endemism (distribution) are defined: A (Eastern temperate South America), B (Central and Southern Chile, including adjacent parts of Argentina), C (Central Argentina) and D (Peru, Far Northern Chile, and Eastern Bolivia). Cladistic biogeographical analyses with TAS, COMPONENT and an algorithm by Enghoff yielded the general area cladogram (A + (C + (B + D))); the one calculated with BPA differed in the position of D: (D + (A + (B + C))). The reconstruction of vicariant events using a protocol by Hovenkamp, corroborates the former general area cladogram, which is compared to competing hypotheses. The history of dispersal and vicariance events is reconstructed with the programme DIVA. Evidence for cospeciation of *Schinus* with its associated psylloids is evaluated with COMPONENT and TREE MAP. The likelihood for cospeciation is high in the *Calophya hermicitae* group, but low in the *Calophya rubra* group and in *Tainarys*. The gall shape depends partly from the psylloid, partly from the *Schinus* phylogeny.

KEYWORDS: Anacardiaceae, biogeography, cladistics, discriminant analysis, Hemiptera, host plant relationships, phylogeny, Psylloidea, *Schinus*, taxonomy.

Introduction

Insects are the most diverse class of organisms, of which a large proportion is associated with plants (Price, 1977; Southwood, 1978; Hammond, 1990). The formation of geographical barriers in species ranges leading to speciation may be too rare to account alone for the large number of species (Strong *et al.*, 1984). Other explanations are cospeciation, in the sense of association by descent, between plants and insects which is, in many respects, similar to geographical vicariance (Humphries *et al.*, 1986; Ronquist, 1995), and host shifts in host specific taxa which allow sympatric speciation (Bush, 1975a, 1975b; Wood, 1987; Butlin, 1988; Tauber and Tauber, 1989). A further mechanism promoting speciation is the specialization on particular organs of the host. Such a specialization is particularly obvious in gall-forming insects of which some 13,000 species have been reported from the orders Thysanoptera, Hemiptera, Coleoptera, Hymenoptera, Lepidoptera and Diptera (Ananthakrishnan, 1984; Dreger-Jauffret and Shorthouse, 1992).

A phylogenetic approach has proved to be very useful in testing hypotheses about the evolution of phytophagous insects (Hafner and Nadler, 1990; Ronquist and Nylin, 1990; Brooks and McLennan, 1991; Mitter *et al.*, 1991; Armbruster, 1992; Anderson, 1993). However, detailed studies are surprisingly scarce.

In the present paper we use the gall-forming hemipterous jumping plant-lice associated with *Schinus* as an example to examine geographical vicariance, cospeciation and gall type as contributors to the psylloid diversity. The necessary taxonomic and phylogenetic base is created with detailed morphological, morphometric and phylogenetic studies.

The plants

Schinus comprises some 30 species of trees and shrubs that are native to temperate South America (Peru, Bolivia, Paraguay, Southern Brazil, Uruguay, Argentina and Chile) (Barkley, 1944, 1957; Dios Muños, 1990; Mabberley, 1990). Barkley (1957) subdivided *Schinus* into the subgenera *Duvaua* and *Euschinus*, and the former into the sections *Euduvaua* and *Pseudoduvaua*. *Schinus* is closely related to the Neotropical genus *Lithrea* and grows naturally as trees or shrubs in open sclerophyll scrub or in the understorey of various temperate forests. Due to considerable morphological variation, the definition and status of some species are problematical. The most widely planted taxon, the pepper tree, is referred to *Schinus molle* L. (Barkley, 1944, 1957; Mabberley, 1990) or *S. areira* L. (Martinez-Crovetto, 1963; Jessop, 1986; Dios Muños, 1990). According to Martinez-Crovetto (1963), *S. molle* occurs in Northeastern Argentina, Southeastern Brazil, Paraguay and Uruguay, and *S. areira* in Northwestern Argentina, Peru and Bolivia. The pepper tree is widely planted as an ornamental for its attractive foliage and showy red fruits in the New World from Central Chile (Hoffmann, 1983) to the Southern USA (Little, 1987), and in tropical highlands and subtropical areas throughout the world (Barfod, 1987). It was introduced into Chile by the Incas (Hoffmann, 1983), and into Central America and

Mexico perhaps also in pre-Columbian times (Barfod, 1987). Its dried fruits are used as a pepper-like condiment or to adulterate pepper. The species is also grown as a shade tree or for reforestation. In addition, it serves in local medicine, as a fertility control, as a purgative for domestic animals or for the preparation of a beverage. Exudates from the trunk, sometimes called American Mastics, are used for chewing (Uphof, 1968; Hoffmann, 1983; Mabberley, 1990). The pepper tree has become naturalized in suitable habitats.

Another species, *Schinus terebinthifolius* Raddi, which is native to Brazil, Argentina, Uruguay and Paraguay, is also grown as an ornamental in warmer regions throughout the world, though less widely than *S. molle* (Barfod, 1987). It has good nectar for bees, is a source of resin and is considered a tonic and an astringent (Uphof, 1968; Morton, 1979; Mabberley, 1990). However, when in bloom it is a major source of respiratory problems and dermatitis for man. Like *S. molle*, it has escaped cultivation and become a pernicious weed in Florida, Bermuda, Bahamas, Hawaii and Australia (Morton, 1979; Ewel, 1986; Bennett *et al.*, 1990).

In Chile, *Schinus latifolius* Engler and *Schinus polygamus* (Cav.) Cabrera (= *S. dependens*) serve in local medicine, are prepared as a beverage, are used as fuel or are planted for fencing (Uphof, 1968; Rodríguez *et al.*, 1983; Hoffmann, 1989, 1991). The latter is a polymorphic shrub restricted to Central Chile and the frontier of Mendoza (Barkley, 1957). Records of *S. polygamus* and *S. dependens* from Eastern Argentina and Uruguay probably concern *S. fasciculatus* (Griseb.) Johnst. (Barkley, 1957) or other closely related species.

The insects

In its native range, *Schinus* is often heavily attacked by insects (Burckhardt, pers. obs.), some of which being restricted to *Schinus* or to Anacardiaceae. With their sometimes conspicuous galls, the cecidogenous taxa have attracted particular attention (Wille, 1926; Houard, 1933; Flores, 1990; Nuñez and Sáiz, 1994; Sáiz and Nuñez, 1997). The galls of jumping plant-lice, which are often numerous, were already known in the 19th century (Karsch, 1880; Scott, 1882; Hieronymus, 1884; Jhering, 1885; Rübsaamen, 1899). The *Schinus* psylloids belong to two genera, *Calophya* Löw (Calophyidae) and *Tainarys* Brèthes (Psyllidae: Rhinocolinae) (Burckhardt, 1988; Burckhardt and Lauterer, 1989).

Burckhardt and Lauterer (1989) listed for the small Neotropical genus *Tainarys* three named species, and each an extant and a fossil undescribed species from Brazil and the Dominican Republic, respectively. All of the described species form irregular or barrel-shaped leaf roll galls on *Schinus* spp. *Tainarys schini* is monophagous on *Schinus fasciculatus*; *T. sordida* and *T. acuticauda* develop on more than one host species (see results, table 18). Two additional species, *T. maculipectus* and *venata* spp. n., were recently discovered in Argentina (Mendoza), Northern and Central Chile on *Schinus polygamus* and *fasciculatus*. Another interesting discovery is that of *Leurolophus oriformae* sp. n. from Argentina, Brazil and Uruguay on leaves of *Lithrea molleoides*, a species originally described in *Schinus*. *Leurolophus*, also belonging to the Rhinocolinae, is known so far from the North American type species associated with *Rhus* (Burckhardt and Lauterer, 1989) and a species from Paraguay without host data (Burckhardt, 1989). These new Rhinocolinae taxa make it necessary to re-examine the generic limits and definitions of *Leurolophus* and *Tainarys*, as well as their phylogenetic relationships.

Calophya, in contrast, is a large, predominantly New World, Oriental and East

Palearctic genus of complex taxonomy. Species are associated with various Anacardiaceae and other families, and are generally highly host specific (see results, table 1). There are five described nominal species which have been reported from *Schinus* spp.: *Calophya duvauae* Scott (1882), *C. williamsoni* Lizer, 1943, *C. rubra* Blanchard (1852), *C. gallifex* (Kieffer and Jörgensen, 1910) and *C. schini* Tuthill, 1959. The first two differ from other *Schinus*-feeding calophyids in the absence of narrow, long genal processes. They have been described from the Buenos Aires and La Pampa Provinces in Argentina. Before its redescription by Burekhardt (1988), *Calophya rubra* was known only from its brief original description (Blanchard, 1852) lacking host records. *Calophya gallifex* was described from Mendoza on the basis of larvae and nipple galls on the leaves of *Schinus dependens*. Later Lizer (1943) and Lizer and Molle (1945) recorded the species from Buenos Aires on *Schinus polygamus*. Tuthill (1959) differentiated *Calophya schini*, a species from Peru and Chile producing pit galls on the leaves of *Schinus molle*, from *C. gallifex* by the adult morphology. The species is also known from California, where it is considered a pest (Downer *et al.*, 1988). Based on adult morphology Burekhardt (1988) synonymized *Calophya williamsoni* with *duvauae*, and *C. gallifex* and *C. schini* with *C. rubra*. The former synonymy is well-founded, but the latter is problematical due to marked differences in gall shape and host species. Recent field work in Chile and the Mendoza area in Argentina by the senior author yielded biological information and material which, supplemented by other sources, suggests that there are at least 14 calophyid species associated with *Schinus*. With multivariate analyses meristic characters were found which separate the morphologically close adults of the species similar to *C. rubra*.

Material and methods

Keys and descriptions

Material was examined or is cited from following institutions: BMNH, Natural History Museum, London, UK; CJBG, Conservatoire et Jardin botaniques, Geneva, Switzerland; DFAS, Department of Food and Agriculture, Sacramento, California, USA; HNHM, Hungarian Natural History Museum, Budapest, Hungary; IAIM, Instituto Argentino de Investigaciones de las Zonas Aridas, Mendoza, Argentina; MACN, Museo Argentino de Ciencias Naturales, Bernardino Rivadavia, Buenos Aires, Argentina; MHNG, Muséum d'histoire naturelle, Geneva, Switzerland; MHNS, Museo Nacional de Historia Natural, Santiago, Chile; MNHN, Muséum National d'Histoire Naturelle, Paris, France; MNHU, Museum für Naturkunde, Humboldt Universität, Berlin, Germany; NHMB, Naturhistorisches Museum, Basle, Switzerland; NHMW, Naturhistorisches Museum, Vienna, Austria; SABC, USDA-ARS South American Biological Control Laboratory, Buenos Aires, Argentina; SCUK, Snow Collection, University of Kansas, USA; UCVA, Universidad Católica de Valparaíso, Valparaíso, Chile; USNM, National Museum of Natural History, Washington, DC, USA.

Morphological terminology follows mostly Hollis (1984) and Ossiannilsson (1992). Measurements are given in mm and were made from slide-mounted specimens as were the drawings.

The following abbreviations are used in the multivariate analyses, descriptions and keys:

Adult: HW, head width; VL, vertex length; GL, genal process length; F1, length

of first antennal flagellomere; AL, antenna length; WL, forewing length; WW, forewing width; RC, length of line connecting apices of veins Rs and Cu_{1a} of forewing; a, length of line connecting base and apex of vein M_{1+2} of forewing; b, length of line connecting apices of veins M_{1+2} and M_{3+4} of forewing; c, length of line connecting apices of veins Cu_{1a} and Cu_{1b} of forewing; d, length of line connecting base and apex of vein Cu_{1b} of forewing; TL, metatibia length; MP, male proctiger length; PL, paramere length; AB, length of proximal segment of aedeagus; AA, length of distal segment of aedeagus; FP, female proctiger length; SL, female subgenital plate length; CL, circumanal ring length; FA, length of apical process of female proctiger. Fifth instar larva: caudal plate ratio, caudal plate length:width ratio.

Host plants

The taxonomy and nomenclature of *Schinus* follows Barkley (1944, 1957), i.e. *Schinus molle* and *areira* are treated as synonyms though the taxon associated with psylloids is *S. areira sensu* Martinez-Crovetto (1963).

Statistical methods—CVA

Differences between the morphometrical measurements obtained from specimens belonging to the *C. rubra* group were evaluated using Canonical Variate Analysis (CVA; otherwise known as ‘discriminant analysis’; e.g. Footitt and Mackauer, 1990; Daly, 1992; Pimentel, 1992), and the programme ADE 3.6 (Chessel and Dolédec, 1992). On the basis of one-way ANOVA, a few measurements, whose variance was low among species, were rejected for the CVA, which was computed separately for both sexes. Eventually, the following measurements were retained for the analyses: HW, VL, F1, AL, WL, WW, RC, a, b, c, d, TL for both sexes; plus MP, AB and AA for males; and FP, SL and FA for females (total 15 variables for both sexes). All measurements were log-transformed for the analyses, to satisfy the assumptions of normality. Statistical differences between the centroids (species) were tested in calculating the Mahalanobis distance between groups and computing the associated F-value (Legendre and Legendre, 1984; Claridge and Nixon, 1986), with the programme ‘Progiciel R’ (Legendre and Vaudor, 1991). This test was performed with the scores of specimens on the first four discriminant axes (see results).

Phylogentic analyses

The cladistic analyses were performed with Hennig86 (Farris, 1988), using the mh and bb* search options. Successive weighting was applied when the first run resulted in several most parsimonious cladograms.

The characters were polarized using outgroup comparison: *Cecidopsylla schimae* Kieffer (analyses of all adult and of selected adult and larval *Calophya*, *Pelmatobrachia* and *Microceropsylla* spp.), *Calophya rhois* (*Calophya rubra* and *C. hermicitae* groups), an ‘all zero outgroup’ (Rhinocolinae), and *Leurolophus oriformae* (*Tainarys*). In all *Calophya* analyses, though the exact sister group relationships are unknown, a closely related taxon could be selected as outgroup. This was not possible for the Rhinocolinae. In the *Tainarys* analysis, of the two closest related genera, *Leurolophus* was preferred to *Notophyllura* as for the former more is known about the larvae.

The cladograms were drawn with MacClade 3.0 (Maddison and Maddison, 1992).

Biogeography

Geographical distributions of organisms can be analysed from a perspective of Earth or of taxon history. The former seeks to find relationships between areas of endemism (or distribution) reflecting events of geological vicariance. The latter aims at explaining distributions of individual groups in terms of geological vicariance, dispersal, extinction, etc.

The mapped distributions of individual species are used here to define the areas of distribution.

Area history. The following three currently available methods were used to translate taxon area cladograms (= TAC) into resolved area cladograms (= RAC) (also termed 'area cladograms' or 'fundamental area cladograms'; Enghoff, 1996): Brooks Parsimony Analysis (BPA: Brooks, 1990), Three Area Statements (TAS: Nelson and Ladiges, 1994, including analysis of paralogy-free subtrees—TASS: Nelson and Ladiges, 1996) and Component Analysis (COMPONENT version 2.0: Page, 1993) (Morrone and Carpenter, 1994).

BPA is similar to the biogeographical assumption 0 (Zandee and Roos, 1987), where widespread species are treated as synapomorphies for the areas they inhabit. With TAS, data can be analysed under assumptions 0 and 1 (areas linked by widespread taxa are treated as monophyletic or paraphyletic) (Nelson and Platnick, 1981); for assumption 2 (areas may be monophyletic, paraphyletic or polyphyletic in respect to widespread taxa) the data have to be modified. COMPONENT 2.0 can treat the data under assumption 0 ('Map widespread associates' on) and assumption 1 ('Map widespread associates' off), but assumption 2 is not directly implemented.

Enghoff (1996) suggested that assumption 0 is most realistic for widespread taxa, whereas assumption 2 should be used for areas of sympatry (redundant distributions). He devised and described in detail an algorithm resolving TACs which is applied to the psyllid data.

Hovenkamp (1997) emphasized the differences between Earth and taxon history protocols, and pointed out that the two approaches require different data and methodologies. In particular the strong analogy of phylogenetic and biogeographical analysis, which is usually taken for granted, is problematical. Whereas the evolution of organismal species is mostly divergent, that of areas may be reticulate. He suggested to use vicariance events rather than areas in biogeographical analysis. The protocol starts with TACs from which traceable vicariance events (= TVE) are extracted; i.e. nodes of which both descendants occupy mutually exclusive areas. For extracting historical information (sequence of TVEs), there must be more than one TVE in each cladogram or branch of cladogram. The next step is to confirm TVEs with information from other groups to get supported vicariance events (SVE). Finally SVEs are arranged in one sequence which is not contradicted by any of the contributing TVEs (Hovenkamp, 1997). Hovenkamp's (1997) procedure was applied to the psyllid data.

Taxon history. Many biogeographic papers examine only vicariance. Data which do not fit general patterns are explained *ad hoc* with dispersal or extinction. Only few studies take the last two phenomena into account, such as the search for ancestral areas (Bremer, 1992, 1995). A quantitative approach of dispersal, vicariance analysis, was described by Ronquist (1997), and is implemented in the programme DIVA 1.1 (Ronquist, 1996). Ancestral distributions are reconstructed based on a three-dimensional step matrix. Optimal ancestral distributions are found in

minimizing dispersal and extinction events. An example illustrating the method is the study of the Ibalidae (Hymenoptera) by Nordlander *et al.* (1996). Here we use DIVA for reconstructing the distributional history of the *Schinus* psylloids.

Cospeciation

Cospeciation analyses compare independently derived host and parasite trees. Phylogenies for the psylloids are reconstructed below. For *Schinus* there is, however, no cladistic information available. A tree is produced here (see results, figure 53) using the infrageneric divisions and groupings of the key by Barkley (1957). The cospeciation analyses were performed with COMPONENT version 2.0 (Page, 1993) and TREE MAP 1.0 (Page, 1995).

In case of incongruent host and parasite trees, COMPONENT constructs a reconciled tree so that the observed host–parasite relationships can be explained by association by descent alone. With COMPONENT, three measures of fit between host and parasite trees can be computed: (1) Number of duplications of a lineage to reconcile the trees. (2) Number of terminal taxa (= leaves) added. This measure corresponds to half the items of error as defined by Nelson and Platnick (1981). (3) Minimum number of independent losses. For judging if there is evidence for cospeciation, these measures were compared to those of 100 random trees.

TREE MAP was used to compare visually the *Schinus* and psylloid associations. Reconstructions were made of the cospeciation history with the greatest number of cospeciation events. For testing the statistical evidence for cospeciation, the number of cospeciation events was compared to those of 999 random host–parasite trees.

Calophyidae **Calophya Löw**

Calophya Löw, 1879: 598. Type species: *Psylla rhois* Löw, by monotypy

Holotrioza Brèthes 1920: 133. *Psylla duvauae* Scott, by monotypy; synonymized by Burckhardt, 1988

Pelmatobrachia Enderlein, 1921: 115. Types species: *Paurocephala spondiasae* Crawford, by original designation. Syn. n.

Microceropsylla Boselli, 1930: 178. Type species *Pauropsylla nigra* Crawford, by original designation. Syn. n.

Paracalophya Tuthill, 1964: 25. Type species: *Paracalophya venusta* Tuthill, by original designation and monotypy; synonymized by Burckhardt, 1988

Neocalophya Miyatake, 1971: 53. Type species *Calophya (Neocalophya) buchanae* Miyatake, by original designation. Syn. n.

Calophya, as redefined here, comprises 48 described and 11 new species associated with various Anacardiaceae, Burseraceae, Rutaceae of the order Rurales, and Fouquieriaceae, Simaroubaceae and Viscaceae (table 1). *Microceropsylla* Boselli and *Pelmatobrachia* Enderlein are here synonymized with *Calophya*. The three taxa together form a monophyletic group within the Calophyidae, based on the straight proximal portion of the aedeagus. The monophyly of *Calophya*, *Microceropsylla* and *Pelmatobrachia* respectively was already questioned by Brown and Hodkinson (1988). The results of two cladistic analyses (see below) confirm this. One of the cladistic analyses further groups the *Schinus* psylloids in two not closely related clades. The *C. rubra* group is characterized by a very homogenous adult morphology. We employed multivariate techniques to find meristic characters to separate morphologically close species.

Table 1. Checklist of *Calophya* spp. with synonymy, distribution and host plants.

-
- acutipennis* Tuthill, 1964. Peru. Host plant unknown.
- andina* sp. n. Argentina, Chile. Host plant: *Schinus montanus* (Philippi) Engler (Anacardiaceae).
- angulipennis* Brown and Hodkinson, 1988. Panama. Host plant unknown.
- arcuata* Caldwell, 1944. USA (Florida). Host plant unknown.
- aurea* Tuthill, 1942. USA (Colorado, Montana, Utah). Host plant: *Rhus trilobata* Nutt. (Anacardiaceae).
- brevicornis* (Crawford, 1919), from *Pauropsylla*, = *Microceropsylla brevicornis*. India, Indonesia. Host plant: *Mangifera indica* L. (Anacardiaceae). Comb. n.
- buchananiae* Miyatake, 1971, from *Calophya* (*Neocalophya*), = *Pelmatobrachia buchananiae*. Palawan. Host plant: *Buchanania arborescens* Blm. (Anacardiaceae). Comb. rev.
- californica* Schwarz, 1904. USA (California, Arizona). Host plants: *Rhus integrifolia* (Nutt.) Brewer and Wats., *R. ovata* Wats. (Anacardiaceae).
- catillicola* sp. n. Argentina. Host plant: *Schinus fasciculatus* (Grieseb.) Johnston (Anacardiaceae).
- clausa* sp. n. Chile. Host plants: *Schinus kauselii* Barkley, *S. montanus* (Philippi) Engler, *S. patagonicus* (Philippi) Johnston (Anacardiaceae).
- clavuligera* sp. n. Argentina, Bolivia, Brazil, Paraguay, Uruguay. Host plants: *Lithrea brasiliensis* L. March, *L. molleoides* (Engler) Vill. (Anacardiaceae).
- dicksoni* Jensen, 1957. Mexico. Host plant: *Fouquieria columnaris* (Kellogg) Kellogg (Fouquieriaceae).
- dubia* Crawford, 1914. USA (Colorado, Montana, Utah). Host plant: *Rhus trilobata* Nutt. (Anacardiaceae).
- duvauae* (Scott, 1882), from *Psylla*, *Holotrioza duvauae*, = *Calopha williamsoni* Lizer, 1943. Argentina. Host plant: *Schinus fasciculatus* (Grieseb.) Johnston (Anacardiaceae).
- evodiae* Yang, 1984. Taiwan. Host plant: *Evodia meliaefolia* (Hance) Benth. (Rutaceae).
- flavida* Schwarz, 1904; = *Calophya flaccida*, misspelling, Hodkinson, 1988. USA (Connecticut, Massachusetts, Missouri, Kansas, Ohio, Washington DC). Host plant: *Rhus glabra* L. (Anacardiaceae).
- floricola* sp. n. Chile, Peru. Host plant: *Schinus molle* L. (Anacardiaceae).
- fusca* Brown and Hodkinson, 1988. Panama. Host plant unknown.
- gallifex* (Kieffer and Jörgensen, 1910), from *Trioza*. Argentina. Host plant: *Schinus fasciculatus* (Grieseb.) Johnston (Anacardiaceae).
- hermicitae* sp. n. Chile. Host plants: *Schinus montanus* (Philippi) Engler, *S. patagonicus* (Philippi) Johnston (Anacardiaceae).
- hyalina* Brown and Hodkinson, 1988. Panama. Host plant unknown.
- longispiculata* (Mathur, 1975), from *Pauropsylla*, *Microceropsylla longispiculata*. India. Host plant: *Buchanania lanzan* Spreng (Anacardiaceae). Comb. n.
- luzonensis* Crawford, 1915. Philippines. Host plant unknown.
- maculata* (Mathur, 1975), from *Pauropsylla*; *Microceropsylla maculata*. India. Host plant: *Mangifera indica* L. (Anacardiaceae). Comb. n.
- mammifex* sp. n. Chile. Host plants: *Schinus latifolius* Engler, *S. polygamus* (Cav.) Cabrera, *S. velutinus* (Turez.) Johnston (Anacardiaceae).
- mangiferae* nomen nov. for *Calophya nigra* (Crawford, 1919), from *Pauropsylla*, *Microceropsylla nigra*; secondary junior homonym of *Calophya nigra* Kuwayama. India, Philippines, Taiwan. Host plant: *Mangifera indica* L. (Anacardiaceae). Comb. n.
- meliorata* Yang, 1984. Taiwan. Host plant unknown.
- minuta* Tuthill, 1942. USA (Arizona). Host plant unknown.
- miramariensis* Brown and Hodkinson, 1988. Panama. Host plant unknown.
- monticola* Brown and Hodkinson, 1988. Costa Rica; Panama. Host plant: *Mauria heterophylla* Kunth (Anacardiaceae).
- nigra* Kuwayama, 1908, = *Calophya viridiscutellata* Kuwayama, 1908, = *Calophya viridis* Kuwayama, 1908. Japan, Russian Far East, Korea. Host plants: *Phellodendron amurense* Rupr. and var. *sachalinense* Fr. Schm. (Rutaceae), *Picrasma quassioides* (D. Don) Benn. (Simaroubaceae). The latter was not confirmed by Miyatake (1992).
- nigrella* Jensen, 1957. USA (California). Host plant: *Rhus trilobata* Nutt. (Anacardiaceae).
-

Table 1. (Continued).

- nigriconis* Brown and Hodkinson, 1988. Panama. Host plant unknown.
- nigridorsalis* Kuwayama, 1908. Japan, Russian Far East, Taiwan. Host plants: *Rhus succedana* L., *R. verniciflua* Stokes, *R. chinensis* Mill., *R. trichocarpa* Miq., *R. ambigua* Lav. (Anacardiaceae).
- nigrilineata* Brown and Hodkinson, 1988. Panama. Host plant: *Tetragastris panamensis* (Engler) O. Kuntze (Burseraceae).
- nigripennis* Riley, 1884, = *Psylla rhois* Glover, 1877, primary junior homonym of *Psylla rhois* Löw, 1877. USA (Connecticut, Florida, Georgia, Maryland, New Jersey, New York, North Carolina, Ohio, Virginia, Washington DC). Host plant: *Rhus capallina* L. (Anacardiaceae).
- orbicola* sp. n. Argentina. Host plant: *Schinus fasciculatus* (Grieseb.) Johnston (Anacardiaceae).
- oweni* Tuthill, 1939. USA (Colorado). Host plant: *Phoradendron juniperinum* Engelm. (only adults) (Viscaceae).
- pallidula* McAtee, 1926. USA (Illinois). Host plant unknown.
- patagonica* sp. n. Argentina, Chile. *Schinus patagonicus* (Philippi) Johnston (Anacardiaceae).
- phellodendri* Loginova, 1976. Russian Far East. Host plant: *Phellodendron amurense* Rupr. (Rutaceae).
- rae* Li, 1992. China. Host plant: *Rhus chinensis* Mill. (Anacardiaceae).
- rhicola* Li, 1993. China. Host plant: *Rhus chinensis* Mill. (Anacardiaceae).
- rhois* (Löw, 1877), from *Psylla*, nec *Psylla rhois* Glover, 1877. China, introduced into Europe, Caucasus. Host plant: *Rhus coggygia* Scop. (Anacardiaceae).
- rotundipennis* White and Hodkinson, 1980. Brazil. Host plant: *Protium* sp. (Burseraceae).
- rubra* (Blanchard, 1851), from *Calinda*. Chile. Host plant: *Schinus polygamus* (Cav.) Cabrera (Anacardiaceae).
- schini* Tuthill, 1959. Bolivia, Peru, introduced into Argentina, Chile, New Zealand, USA (California). Host plant: *Schinus molle* L. (Anacardiaceae).
- scrobicola* sp. n. Chile. Host plant: *Schinus polygamus* (Cav.) Cabrera (Anacardiaceae).
- shinjii* Sasaki, 1954. Japan; = *Psylla sorbi* Shinji, 1944 nec Linnaeus, 1758. Host plant: *Picrasma quassioides* (D. Don.) Benn. (Simaroubaceae).
- spondiasae* (Crawford, 1915), from *Pauropsylla*, *Pelmatobranchia spondiasiae*. India. Host plant: *Spondias pinnata* (L.) Kurz (Anacardiaceae). Comb. n.
- stigmotacta* Brown and Hodkinson, 1988. Panama. Host plant unknown.
- terebinthifolii* sp. n. Brazil. Host plant: *Schinus terebinthifolius* Raddi (Anacardiaceae).
- triangula* Yang, 1984. Taiwan. Host plant unknown.
- triozomima* Schwarz, 1904; = *Calophya triozomima claripennis* Crawford, 1914. USA (Arizona, California, Colorado, Idaho, Utah). Host plant: *Rhus trilobata* Nutt. (Anacardiaceae).
- venusta* (Tuthill, 1964), from *Paracalophya*. Peru. Host plant: *Loxopterygium huasango* Spruce ex Engl. (Anacardiaceae).
- verrucosa* (Mathur, 1975), from *Pauropsylla*, *Microceropsylla verrucosa*. India. Host plant: *Semecarpus anacardium* L. (Anacardiaceae). Comb. n.
- verticis* (Crawford, 1919), from *Pauropsylla*, *Microceropsylla verticis*. Indonesia, Friendly Is., Tonga, Vava'u. Host plant unknown. Comb. n.
- verticornis* Kwon, 1983. South Korea, Japan. Host plant unknown.
- washingtonia* (Klyver, 1931), from *Hemitrioza*. USA (Washington). Host plant unknown.
- Undescribed species
- vitreipennis* Riley, 1884, nomen nudum. USA (Arizona). Host plant unknown.
- sp. A, Brown and Hodkinson, 1988. Panama. Host plant unknown.
- sp. B, Brown and Hodkinson, 1988. Panama. Host plant unknown.
- sp. C, Brown and Hodkinson, 1988. Panama. Host plant unknown.
- sp. D, Brown and Hodkinson, 1988. Panama. Host plant unknown.
- sp., Rübсаamen, 1908. Brazil: Estado de Rio de Janeiro, Tijuca, vii.1899. Host plant: *Zanthoxylum* sp. (Rutaceae). Forming pit galls on the leaves.

Multivariate analysis

Statistical results—CVA

Males. Most of the variance in morphometrical measurements is explained by 6–7 discriminant axes (figure 1a), but we restrict our attention here to the first four axes, which explain together about 65% of the variance. The first axis (17.8% of the variance) is probably related to a size effect, segregating the species according to their size (figure 1b). It is best explained by head width (HW) and other variables related to the genitalia (AB, MP; figure 1c, table 2). The formation of the second axis (16.8% of the variance) is more obscure but is most influenced by variables such as VL, AA and d (figure 1c, table 2). The third axis (16.8% of the variance) is most influenced

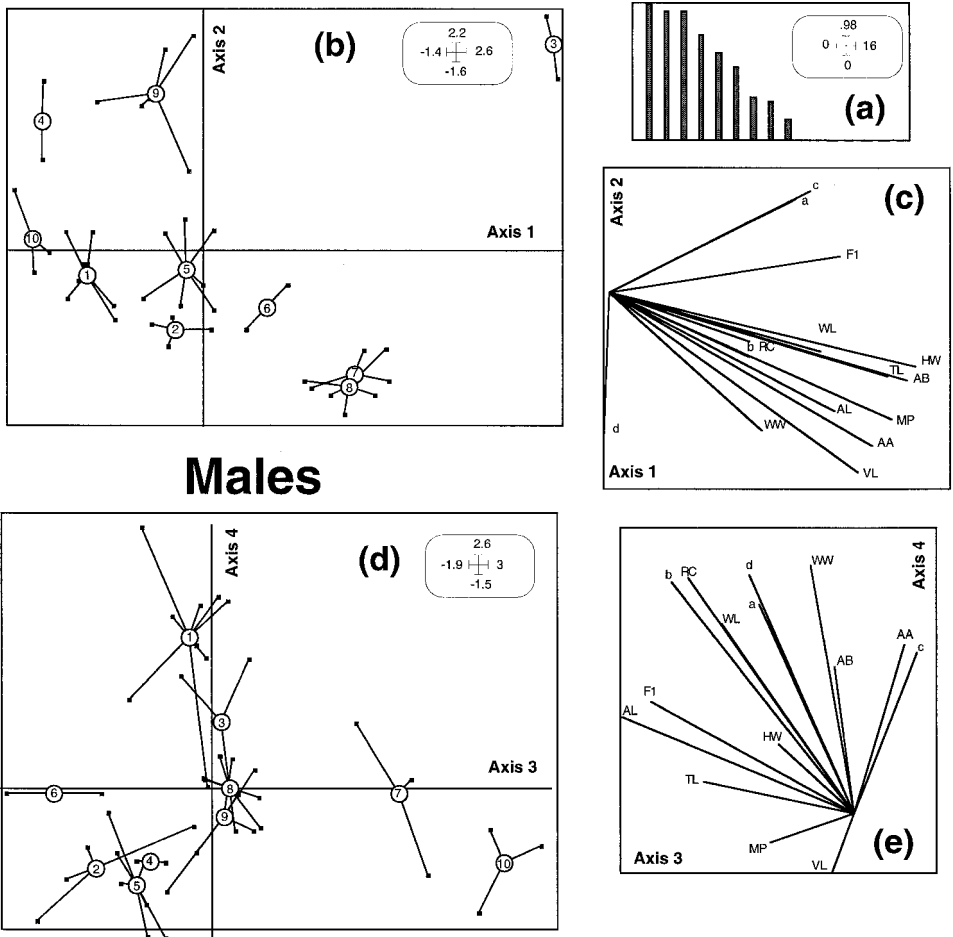

FIG. 1. Canonical variate analysis of 44 male specimens measured in the *C. rubra* group. (a) Distribution of eigenvalues among the discriminant axes; (b) plot of the specimens projected on discriminant axes 1 and 2; (c) correlation circle of variables projected on axes 1 and 2; (d) plot of the specimens projected on axes 3 and 4; (e) correlation circle of variables projected on axes 3 and 4. Species codes as follows: 1 = *C. andina*, 2 = *C. clausa*, 3 = *C. floricola*, 4 = *C. gallifex*, 5 = *C. mammifex*, 6 = *C. orbicola*, 7 = *C. patagonica*, 8 = *C. rubra*, 9 = *C. schini*, 10 = *C. scrobicola*. Codes of variables (measurements) as detailed in the methods.

Table 2. Summary of the discriminant analyses for males and females of the *C. rubra* group. Correlations between canonical variables and variables of origin (first entry, **in bold**) and coefficients of discriminant scores (second entry) for each of the four first discriminant axes.

Variable	Males				Females			
	Axis 1	Axis 2	Axis 3	Axis 4	Axis 1	Axis 2	Axis 3	Axis 4
HW	0.85 0.140	-0.21 0.309	-0.20 0.392	0.18 -0.245	0.74 0.209	0.47 0.491	-0.07 -0.484	0.13 -0.129
VL	0.69 0.216	-0.49 -0.184	-0.56 0.168	-0.16 -0.259	0.68 -0.014	0.15 -0.254	-0.48 -0.543	0.20 0.515
F1	0.64 0.135	0.10 1.106	-0.53 -0.167	0.30 0.412	0.39 -0.201	0.56 0.064	0.43 0.446	-0.23 -0.243
AL	0.62 -0.114	-0.33 -0.532	-0.61 -0.958	0.25 -0.033	0.55 0.244	0.51 0.173	0.14 -0.187	-0.19 0.129
WL	0.59 0.409	-0.16 0.124	-0.34 0.147	0.50 -1.494	0.61 -0.216	0.38 0.111	0.13 -0.566	0.11 2.035
WW	0.42 0.008	-0.38 -0.134	-0.11 0.083	0.65 0.394	0.67 -0.084	0.09 -0.746	0.44 -0.293	-0.02 -0.644
RC	0.39 -0.415	-0.13 -0.540	-0.43 -0.388	0.62 0.507	0.57 0.191	0.35 0.142	0.21 0.678	-0.03 -1.247
a	0.52 0.213	0.26 0.430	-0.24 0.025	0.55 0.248	0.31 -0.042	0.43 -0.026	0.55 0.286	0.21 0.129
b	0.39 -0.003	-0.18 0.026	-0.47 -0.210	0.61 0.326	0.45 -0.264	0.27 -0.247	0.39 -0.129	0.05 0.650
c	0.56 0.034	0.29 0.084	0.17 0.185	0.42 -0.025	0.30 -0.123	0.42 0.111	0.49 0.349	0.31 0.050
d	0.02 0.488	-0.41 -0.272	-0.27 0.099	0.63 0.332	0.12 -0.040	-0.01 -0.341	0.12 -0.035	-0.12 -0.269
TL	0.77 0.292	-0.23 -0.298	-0.39 -0.139	0.08 -0.194	0.74 0.423	0.48 0.133	0.06 0.127	-0.22 -1.475
MP	0.78 0.119	-0.35 -0.486	-0.22 -0.233	-0.07 -0.567	—	—	—	—
AB	0.83 0.304	-0.24 0.425	-0.05 0.065	0.38 0.955	—	—	—	—
AA	0.73 0.157	-0.42 -0.471	0.13 0.693	0.44 0.311	—	—	—	—
FP	—	—	—	—	0.91 0.578	-0.83 0.293	0.25 0.043	0.20 1.049
SL	—	—	—	—	0.82 -0.092	-0.06 -0.089	0.30 0.305	0.32 0.604
FA	—	—	—	—	0.84 0.347	-0.30 -0.870	0.27 0.362	0.18 -1.180

by head characters such as AL, VL and F1, whereas the fourth axis (13.8% of the variance) depends more on wing characters such as WW, RC, d and b (figure 1e, table 2). The correlation between canonical variables and variables of origin, and the coefficients of discriminant scores are detailed in table 2 for males and females.

Overall, a projection of the male scores into the plane formed by axes 1 and 2 show rather well-delimited centroids, with the exception of *C. patagonica* and *C. rubra* (figure 1b). These two species are easily differentiated in the plane formed by axes 3 and 4 (figure 1d). Overall, on the four axes, their centroids are significantly different from each other (table 3). The least well-differentiated centroid is that of

Table 3. Lower matrix of probabilities testing whether each pair of species in the *C. rubra* group is different from each other when the scores of the first four discriminant axes are considered. F values were first calculated on the basis of the Mahalanobis distance (see methods) and results are presented separately for both sexes. Probabilities in bold are > 0.05 and may indicate species pairs difficult to distinguish from each other.

Species	<i>mammi-</i>								
	<i>andina</i>	<i>clausa</i>	<i>floricola</i>	<i>gallifex</i>	<i>fex</i>	<i>orbicola</i>	<i>patagonica</i>	<i>rubra</i>	<i>schini</i>
Males									
<i>C. clausa</i>	0.0005	—	—	—	—	—	—	—	—
<i>C. floricola</i>	0.0000	0.0071	—	—	—	—	—	—	—
<i>C. gallifex</i>	0.0064	0.2773	0.0117	—	—	—	—	—	—
<i>C. mammifex</i>	0.0000	0.1784	0.0001	0.0121	—	—	—	—	—
<i>C. orbicola</i>	0.0001	0.2966	0.0137	0.0929	0.0723	—	—	—	—
<i>C. patagonica</i>	0.0001	0.0369	0.0021	0.0261	0.0001	0.0866	—	—	—
<i>C. rubra</i>	0.0000	0.0007	0.0025	0.0200	0.0001	0.0602	0.0021	—	—
<i>C. schini</i>	0.0001	0.0042	0.0004	0.0127	0.0018	0.0016	0.0003	0.0001	—
<i>C. scrobicola</i>	0.0000	0.0414	0.0341	0.1584	0.0001	0.0743	0.0067	0.0004	0.0003
Females									
<i>C. clausa</i>	0.0027	—	—	—	—	—	—	—	—
<i>C. floricola</i>	0.0004	0.0511	—	—	—	—	—	—	—
<i>C. gallifex</i>	0.0063	0.1057	0.1154	—	—	—	—	—	—
<i>C. mammifex</i>	0.0000	0.0315	0.0000	0.0000	—	—	—	—	—
<i>C. orbicola</i>	0.0023	0.1300	0.2382	0.0952	0.0001	—	—	—	—
<i>C. patagonica</i>	0.0008	0.0096	0.0640	0.1687	0.0000	0.2288	—	—	—
<i>C. rubra</i>	0.0000	0.0001	0.0000	0.0001	0.0000	0.0008	0.0002	—	—
<i>C. schini</i>	0.0001	0.0004	0.0019	0.0745	0.0000	0.0013	0.0003	0.0000	—
<i>C. scrobicola</i>	0.0252	0.1252	0.1023	0.1202	0.0001	0.0777	0.0345	0.0001	0.0134

C. orbicola, which can only be considered significantly different from those of *C. andina*, *C. floricola* and *C. schini* (table 3). Out of 45 pair-wise comparisons, nine (20%) point out to possible problems when relying solely on morphometrical characters for the diagnosis of male specimens within the *C. rubra* group. On the other hand, *C. andina*, *C. floricola* and *C. schini* appear to be the most readily distinguished species by morphometrical measurements alone.

Females. The results of the CVA for female specimens are not extremely different from those for the male specimens. Most of the variance is also explained by 6–7 axes (figure 2a) and the contribution of each of the four axes to the total variance is 18.9%, 17.3%, 16.3% and 14.0%, respectively. Axis 1 is mostly influenced by genital characters such as FP, FA and SL; axis 2 by FP and F1 (figure 2c, table 2); axis 3 by a, c and VL; and axis 4 by SL and c (figure 2e, table 2). The projections on the planes formed by axes 1–2 and 3–4 (figure 2b, d) suggest that species differentiation is more difficult with female specimens than with male specimens and this is confirmed when testing for significant differences between centroids (table 3). Out of the 45 possible comparisons, 13 are not significant (29% of cases). The most difficult females to distinguish on the basis of morphometric measurements alone are those of *C. gallifex* and *C. orbicola*, whereas the most distinct ones are those of *C. andina*, *C. mammifex* and *C. rubra* (table 3).

Discussion—CVA

Despite the homogeneity of the adult morphology in the *Calophya rubra* group, the CVA differentiates all the species. Meristic characters which are regularly used

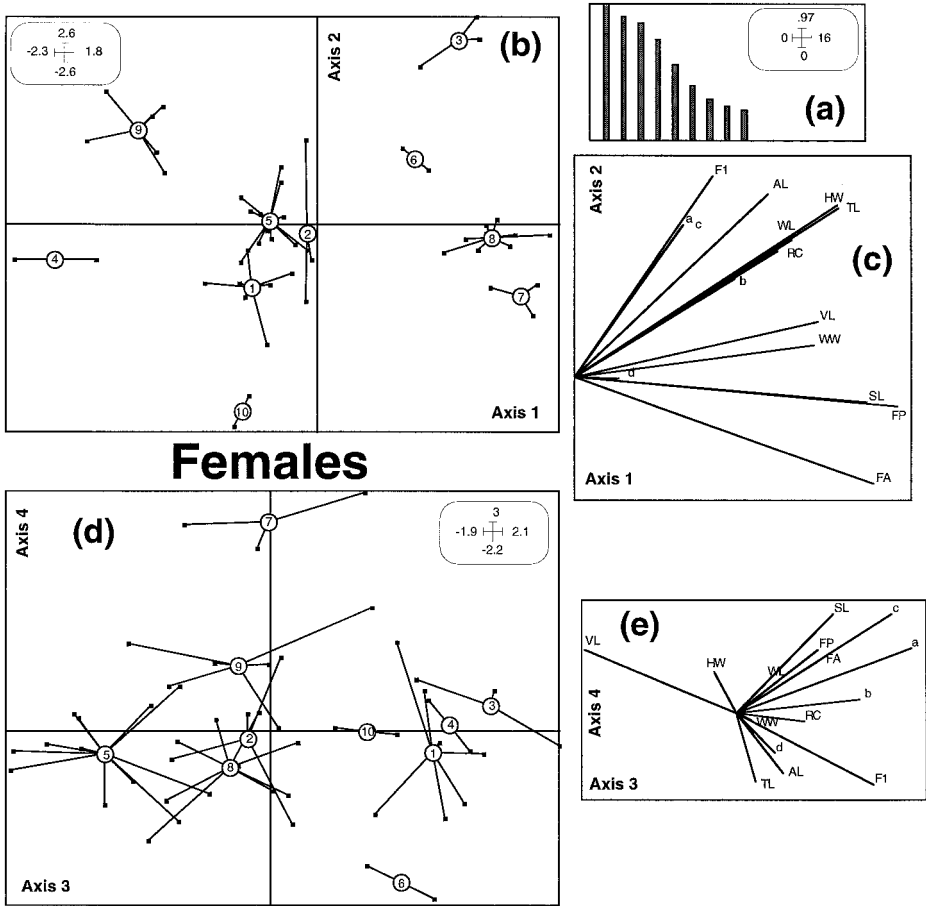

FIG. 2. Canonical variate analysis of 50 female specimens measured in the *C. rubra* group. (a) Distribution of eigenvalues among the discriminant axes; (b) plot of the specimens projected on discriminant axes 1 and 2; (c) correlation circle of variables projected on axes 1 and 2; (d) plot of the specimens projected on axes 3 and 4; (e) correlation circle of variables projected on axes 3 and 4. Species and variable codes as in figure 1.

in psylloid taxonomy make also important contributions in the CVA: e.g. HW, VL, AL, and WW for males; FP, a, SL for females. In the key we will use HW, WL, TL, MP, AA and FP to separate pairs of species.

The analyses of males and females differ slightly in the groupings of species and in the amount of contribution of the variables, which is mostly the result from the three genitalic characters. Globally it may be easier to use males if given the choice, but certain pairs of species are more readily distinguished by females (e.g. *C. patagonica* and *C. rubra*).

Although several species pairs may be difficult to differentiate overall on the basis of morphometric measurements alone (table 3), in all cases there are qualitative characters such as the presence/absence of surface spinules on the forewing, the shape of aedeagus, the vertex setosity, etc. (cf. key to adults) which clearly distinguish these species (e.g. *C. clausa* and *C. gallifex* which differ in the forewing shape).

Key to adults

(Adults of *C. clavuligera* unknown)

- 1 Head and thorax pitch black, strongly contrasting with green or yellow abdomen. Distal segment of aedeagus short (figure 4D). Female genitalia short, proctiger without apical spiniform process (figure 4B). 2
 - Body coloration different; entirely light or dark, or thorax variegated. Distal segment of aedeagus long (figure 3I, K). Female genitalia long, proctiger with apical spiniform process (figure 3B, C) 4
- 2 Forewing base dark brown to black, remainder colourless. Male parameres, in profile, lanceolate (figure 6K); basal stalk of distal portion of aedeagus less than a quarter of total segmental length (figure 6J). Female subgenital plate truncate apically (figure 6G) *hermicitae* sp. n.
 - Forewing entirely colourless. Male paramere, in profile, lamellar (figure 4E); basal stalk of distal portion of aedeagus more than a third of total segmental length (figure 4D). Female subgenital plate acute apically (figure 4B). 3
- 3 Forewings, in addition to radular spinules, bearing surface spinules in distal half. Genitalia as in figure 10B–F. *terebinthifolii* sp. n.
 - Forewings, except for radular spinules, without surface spinules in distal half. Genitalia as in figure 4B–E. *catillicola* sp. n.
- 4 Genal processes short, broadly rounded apically. *duvauae* (Scott)
 - Genal processes long, strongly tapering to apex. 5
- 5 Forewings, in addition to radular spinules, bearing surface spinules in distal half. 6
 - Forewings, except for radular spinules, without surface spinules in distal half. 7
- 6 Smaller species: MP < 0.20, FP < 0.4. Body colour light (predominantly green or yellow). Genitalia as in figure 9B–E, G. *schini* Tuthill
 - Larger species: MP > 0.22, FP > 0.6. Body colour dark (predominantly brown). Genitalia as in figure 8B–F. *patagonica* sp. n.
- 7 Vertex covered in conspicuous long setae. Parameres long and slender (figure 5I). Female genitalia as in figure 5H. *floricola* sp. n.
 - Setae on vertex shorter and less conspicuous. Parameres short and stout (figure 3H, J). Female genitalia different. 8
- 8 Forewings widest in the middle, narrowly rounded apically (figure 4F). Vertex with very short setae anteriorly. 9
 - Forewings widest in apical third, broadly rounded apically (figure 3A). Vertex with moderately long setae anteriorly. 14
- 9 Males 10
 - Females. 12
- 10 Apical dilatation of distal segment of aedeagus long (figure 8L). *rubra* (Blanchard)
 - Apical dilatation of distal segment of aedeagus short (figures 4K, 7G). 11
- 11 Smaller species: MP < 0.22, AA < 0.17. *clausa* sp. n.
 - Larger species: MP > 0.24, AA > 0.20. *orbicola* sp. n.
- 12 Smaller species: FP < 0.40. *clausa* sp. n.
 - Larger species: FP > 0.43. 13
- 13 TL/HW < 0.82. Chile. *rubra* (Blanchard)
 - TL/HW > 0.83. Argentina. *orbicola* sp. n.
- 14 Males 15
 - Females 18
- 15 Apical dilatation of distal segment of aedeagus about half as long as entire segment (figure 9K) *scrobicola* sp. n.
 - Apical dilatation of distal segment of aedeagus less than a third as long as entire segment (figure 3I, K). 16

- 16 Distal segment of aedeagus with relatively small apical dilatation and long, straight shaft (figure 3I, K). *andina* sp. n.
- Distal segment of aedeagus with relatively large apical dilatation and short, curved shaft (figure 6E). 17
- 17 Proctiger thick-set (figure 7F). Distal segment of aedeagus with globular apical dilatation (figure 7D). Chile. *mammifex* sp. n.
- Proctiger slender (figure 6C). Distal segment of aedeagus with oval apical dilatation (figure 6E). Argentina. *gallifex* (Kieffer and Jörgensen)
- 18 Subgenital plate short, truncate apically (figure 7E) *mammifex* sp. n.
- Subgenital plate long, subacute apically (figure 3B, C). 19
- 19 HW > 0.5. On *Schinus montanus*, *S. patagonicus*. *andina* sp. n.
- HW < 0.5. On *Schinus fasciculatus*, *S. polygamus* 20
- 20 FP < 0.26, WL > 1.65. Argentina *gallifex* (Kieffer and Jörgensen)
- FP > 0.34, WL < 1.65. Chile *scrobicola* sp. n.

Key to last instar larvae

(Larvae of *C. floricola* unknown)

- 1 Antennae short, irregularly triangular or sinuous (figures 13, 20). Margin of wing buds with lanceolate or sectasetae. Circumanal ring oval. In open pit galls. 2
- Character combination different. In closed nipple, conical, disk, spherical or nut galls on the leaves, branches or flowers. 7
- 2 Antennae strongly sinuous (figure 20). 3
- Antennae irregularly triangular or with a broad base from which a slender process rises in the middle (figure 13). 4
- 3 Humeral lobes large, ending beyond anterior eye margin. Wing buds and abdomen without dorsal processes and horns (figure 20). On *Schinus molle*. *schini* Tuthill
- Humeral lobes small, ending in the middle of eye margin. Bases of wing buds with dorsal processes, abdomen with a median dorsal row of horns (figure 21). On *Schinus polygamus*. *scrobicola* sp. n.
- 4 Lobes of anterior head margin almost straight bearing very slender sectasetae (figure 13). On *Lithrea* spp. *clavuligera* sp. n.
- Lobes of anterior head margin broadly rounded bearing diamond-shaped sectasetae or lanceolate setae (figure 15). 5
- 5 Tarsi with small but distinct claws. On *Schinus terebinthifolius*. *terebinthifolii* sp. n.
- Tarsi without or indistinct claws. On other *Schinus* spp. 6
- 6 On *Schinus montanus*, *S. patagonicus*. *hermicitae* sp. n.
- On *Schinus fasciculatus*. *catillicola* sp. n.
- 7 Body covered in long fine setae. In large spherical galls on the leaves of *S. fasciculatus* *duvauae* (Scott)
- Body without long setae. 8
- 8 Antennae strongly curved downwards. Circumanal ring reduced (figure 17). In disk or spherical galls on the leaves of *Schinus fasciculatus*. *orbicola* sp. n.
- Antennae straight, directed sideways. Circumanal ring developed (figure 11). 9
- 9 Abdomen without dorsal horn. Circumanal ring oval (figure 14). 10
- Abdomen with a median row of conspicuous dorsal horns. Circumanal ring circular (figure 12). 11
- 10 Forewing buds with many marginal lanceolate or sectasetae, regularly spaced about one seta length from each other (figure 14). In conical leaf margin galls on *Schinus fasciculatus* *gallifex* (Kieffer and Jörgensen)
- Forewing buds with few marginal lanceolate setae, irregularly spaced more than one

- seta length from each other (figure 18). In disk or spherical leaf galls on *Schinus patagonicus*. *patagonica* sp. n.
- 11 Abdominal marginal lanceolate setae slender (figure 19). In nut galls on twigs and branches of *Schinus polygamus*. *C. rubra* (Blanchard)
- Abdominal marginal lanceolate setae thick (figure 11). In nipple galls on the leaves or nut galls on the flowers of various *Schinus* spp. 12
- 12 On *Schinus latifolius*, *S. polygamus*, *S. velutinus*. *mammifex* sp. n.
- On *Schinus krausii*, *S. montanus*, *S. patagonicus*. 13
- 13 Larger. Antennal flagellum short, conical (figure 11). *andina* sp. n.
- Smaller. Antennal flagellum long, tubular (figure 12). *clausa* sp. n.

Key to galls

(Galls of *C. floricola* unknown)

- 1 Open pit gall (figures 59, 62) 2
- Closed nipple, disk, spherical or nut gall (figures 57, 58, 60, 61). 7
- 2 On *Lithrea brasiliensis* or *L. molleoides*. *clavuligera* sp. n.
- On *Schinus* spp. 3
- 3 On *Schinus montanus* or *S. patagonicus*. *hermicitae* sp. n.
- On other spp. 4
- 4 On *Schinus molle*. *schini* Tuthill
- On other spp. 5
- 5 On *Schinus terebinthifolius*. *terebinthifolii* sp. n.
- On other spp. 6
- 6 Argentina. On *Schinus fasciculatus*. *catillicola* sp. n.
- Chile. On *Schinus polygamus*. *scrobicola* sp. n.
- 7 On *Schinus krausii*, *S. montanus* or *S. patagonicus*. 8
- On other *Schinus* spp. 9
- 8 Gall disk-shaped or spherical, orifice without hairs. *patagonica* sp. n.
- Gall nipple-shaped, orifice with conspicuous hairs, brush-like (figures 57, 58). *andina* sp. n., *clausa* sp. n.
- 9 Nut gall (figure 61). 10
- Nipple, disk, conical or spherical gall (figure 60) 11
- 10 Gall on stem and branchlets (figure 61). *rubra* (Blanchard)
- Gall on flowers. *mammifex* sp. n.
- 11 Disk or hemispherical gall. 12
- Nipple or conical gall. 13
- 12 Disk gall. *orbicola* sp. n.
- Hemispherical gall. *duvauae* (Scott)
- 13 Cone-shaped gall at leaf margin. *gallifex* (Kieffer and Jörgensen)
- Nipple gall on leaf blade (figure 60). *mammifex* sp. n.

Calophya andina sp. n.

(figures 3, 11)

Description. Adult. Coloration. Head and body dark brown with irregular lighter pattern. Antennal segments 1, 2, 9 and 10 almost black, 3–8 ochreous or light greyish brown. Legs ochreous, apical tarsal segments brown. Forewings transparent, veins ochreous to brown. Young specimens with more extended yellow or green coloration.

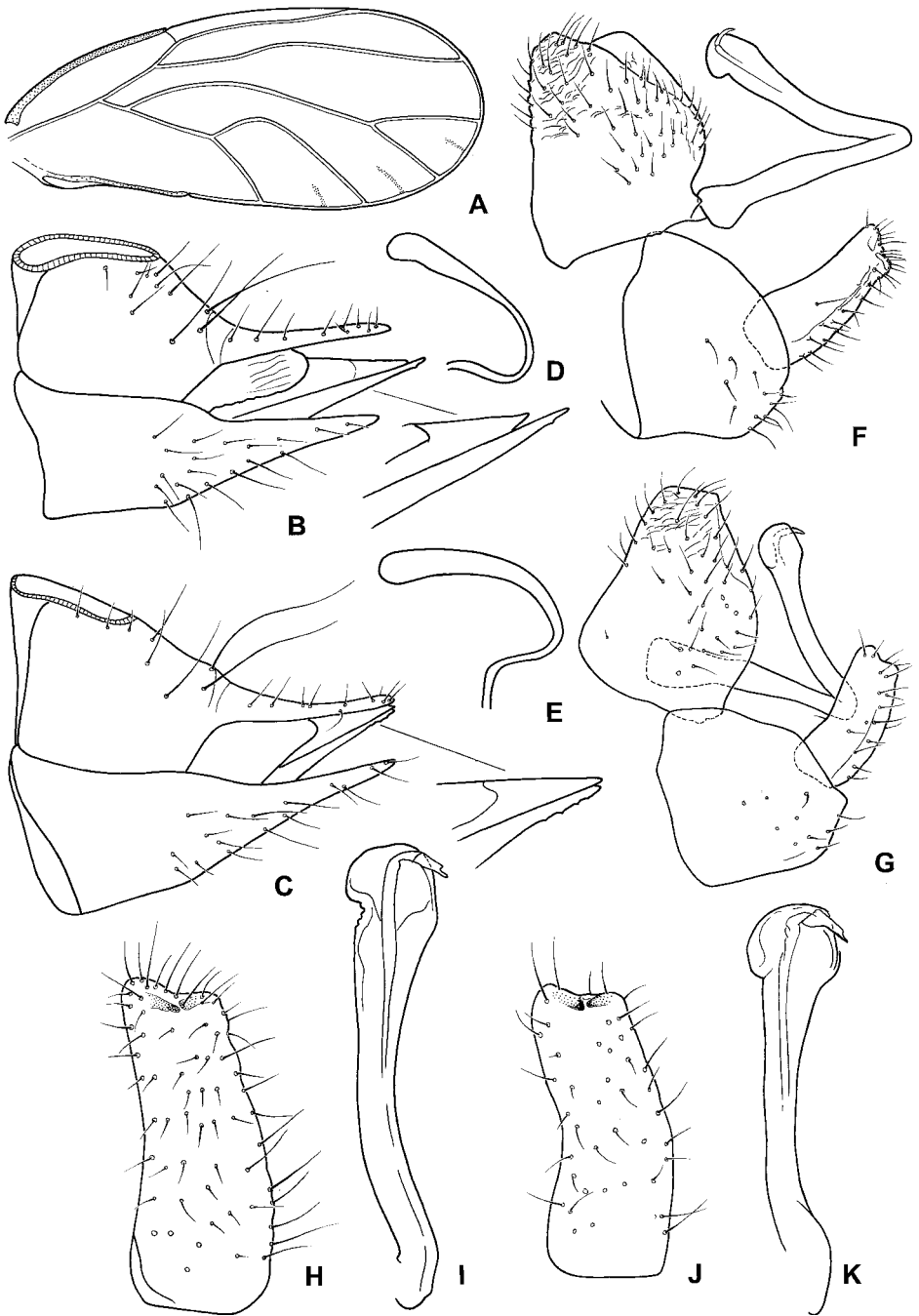

FIG. 3. *Calophya andina*: A, forewing; B, C, female genitalia, in profile; D, E, spermatheca; F, G, male genitalia, in profile; H, I, paramere, inner face; J, K, distal segment of aedeagus.

Structure. Anterior portion of vertex covered in short setae which are about as long as distance between them; genal processes moderately long, slender, contiguous in the middle. Forewings (figure 3A) oval, widest in apical third, evenly, broadly

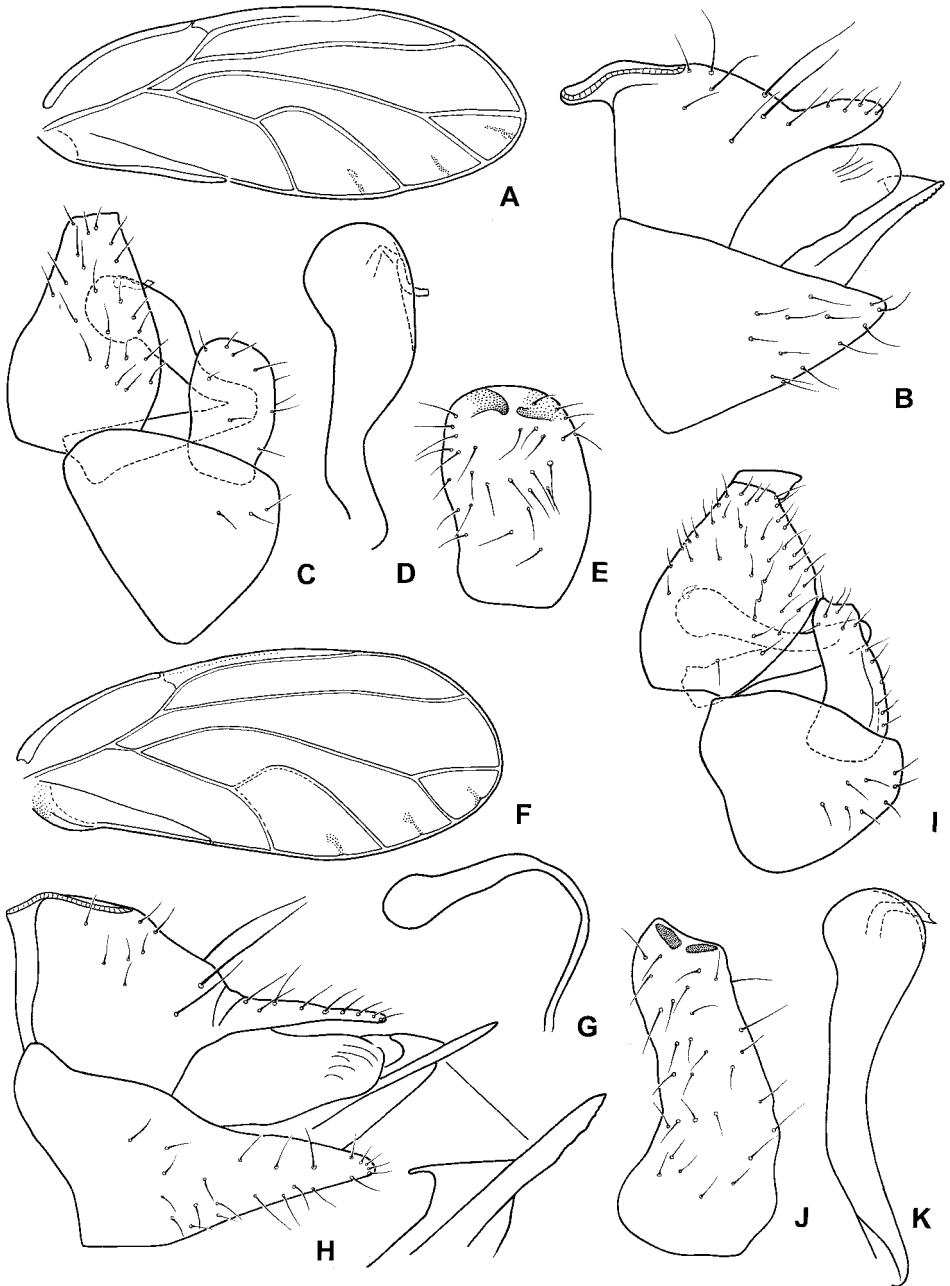

FIG. 4. *Calophya* spp.: A–E, *C. catillicola*; F–K, *C. clausa*. A, F, forewing; B, H, female genitalia, in profile; C, I, male genitalia, in profile; D, K, distal segment of aedeagus; E, J, paramere, inner face; G, spermatheca.

rounded apically; surface spinules, apart from base of cell cu_2 , absent. Genitalia as in figure 3B–K. Male subgenital plate short; proctiger massive; paramere long, truncate apically; distal portion of aedeagus long with straight, long shaft and short

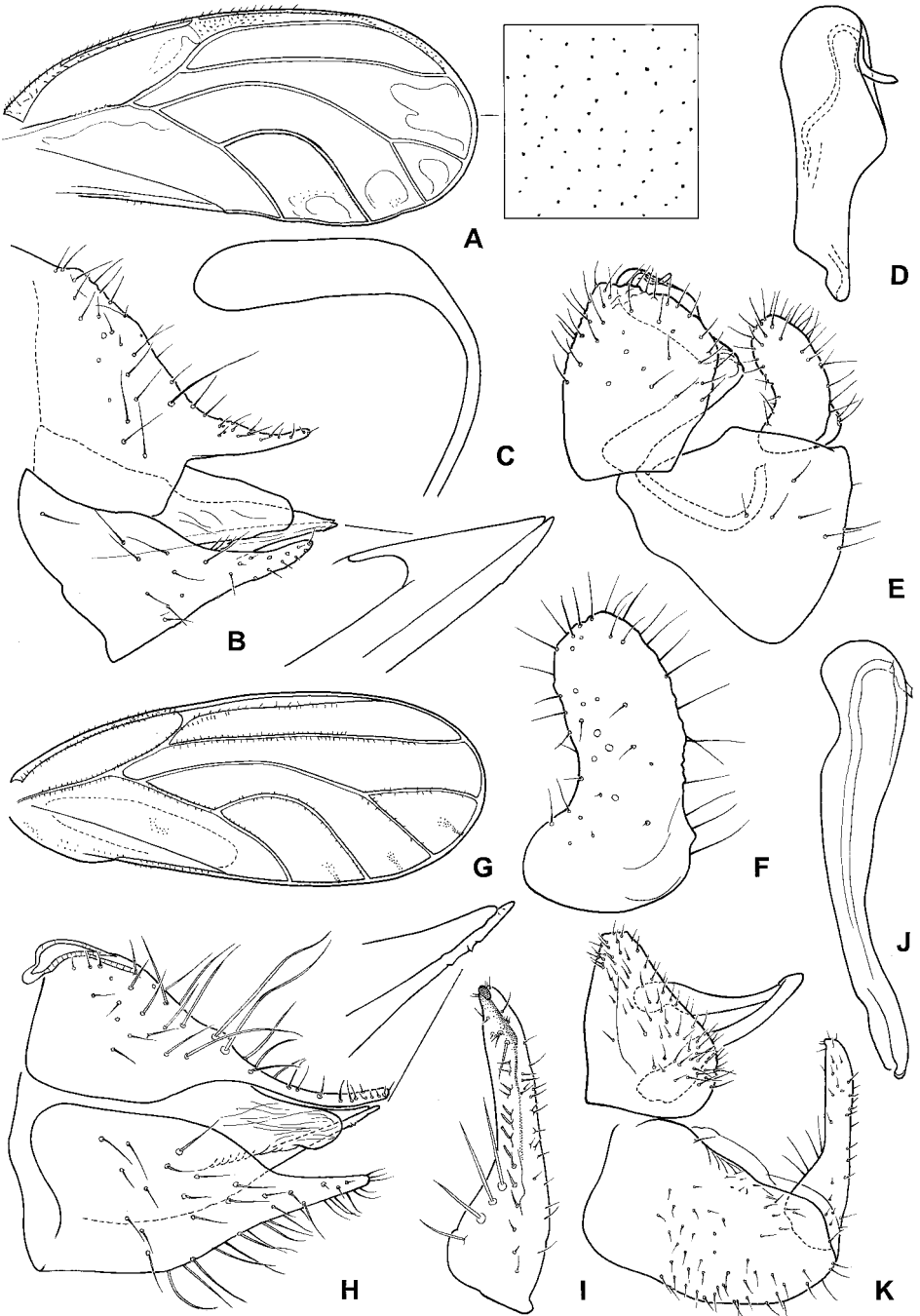

FIG. 5. *Calophya* spp.: A–F, *C. duvauae*; G–K, *C. floricola*. A, G, forewing; B, H, female genitalia, in profile; C, spermatheca; D, J, distal segment of aedeagus; E, K, male genitalia, in profile; F, I, paramere, inner face.

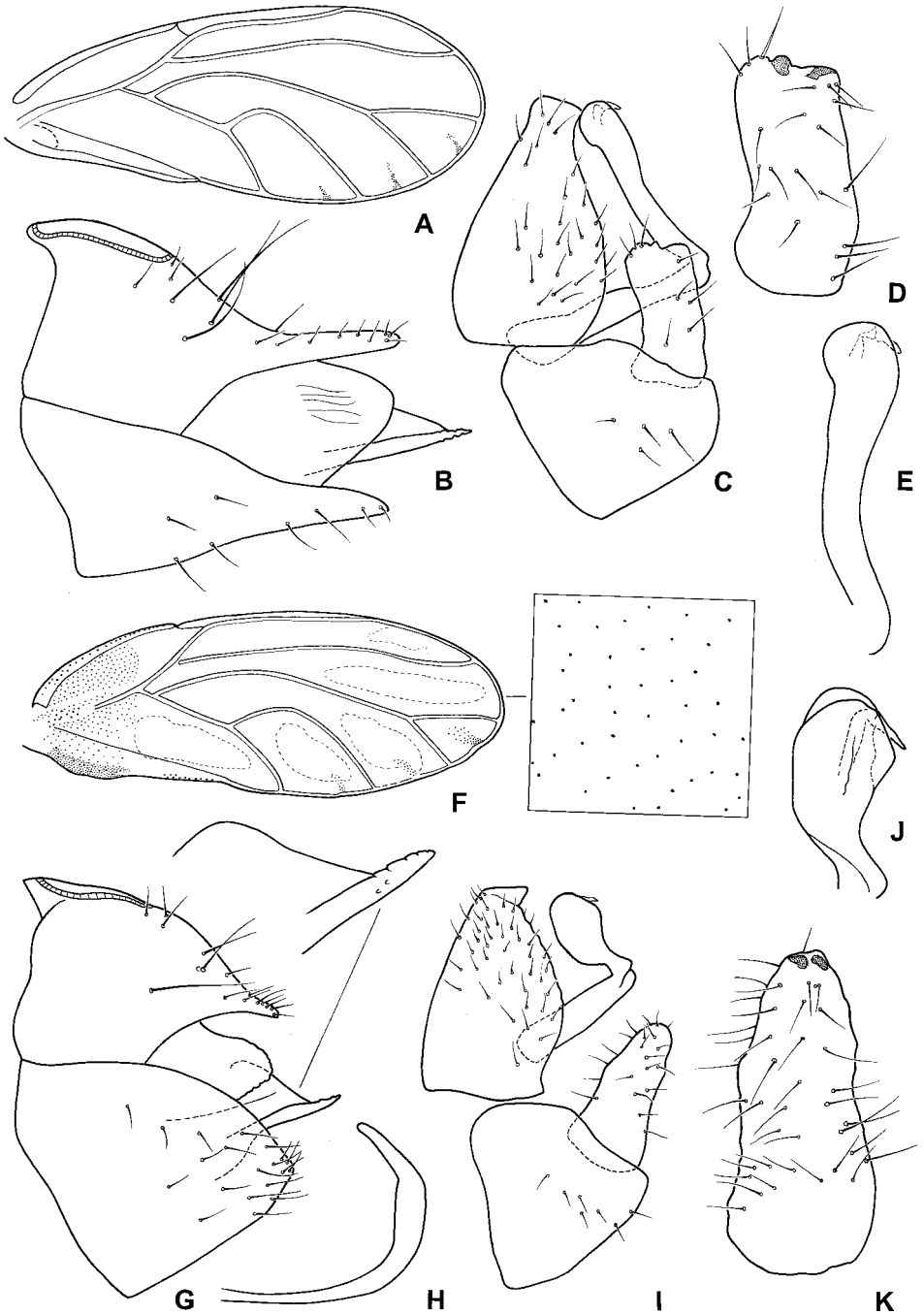

FIG. 6. *Calophya* spp.: A–E, *C. gallifex*; F–K, *C. hermicitae*. A, F, forewing; B, G, female genitalia, in profile; C, I, male genitalia, in profile; D, K, paramere, inner face; E, J, distal segment of aedeagus; H, spermatheca.

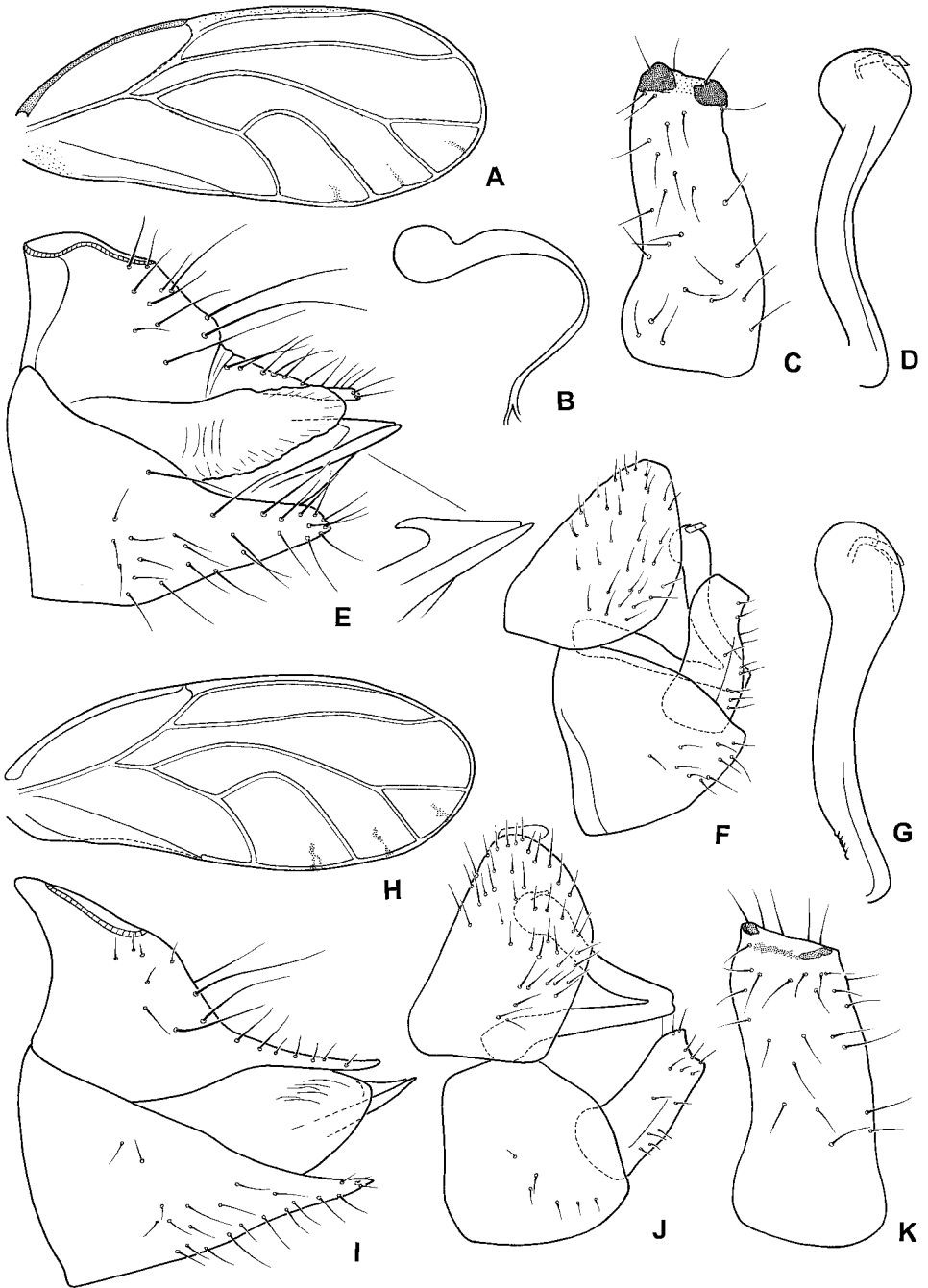

FIG. 7. *Calophya* spp.: A–F, *C. mammifex*; G–K, *C. orbicola*. A, H, forewing; B, spermatheca; C, K, paramere, inner face; D, G, distal segment of aedeagus; E, I, female genitalia, in profile; F, J, male genitalia, in profile.

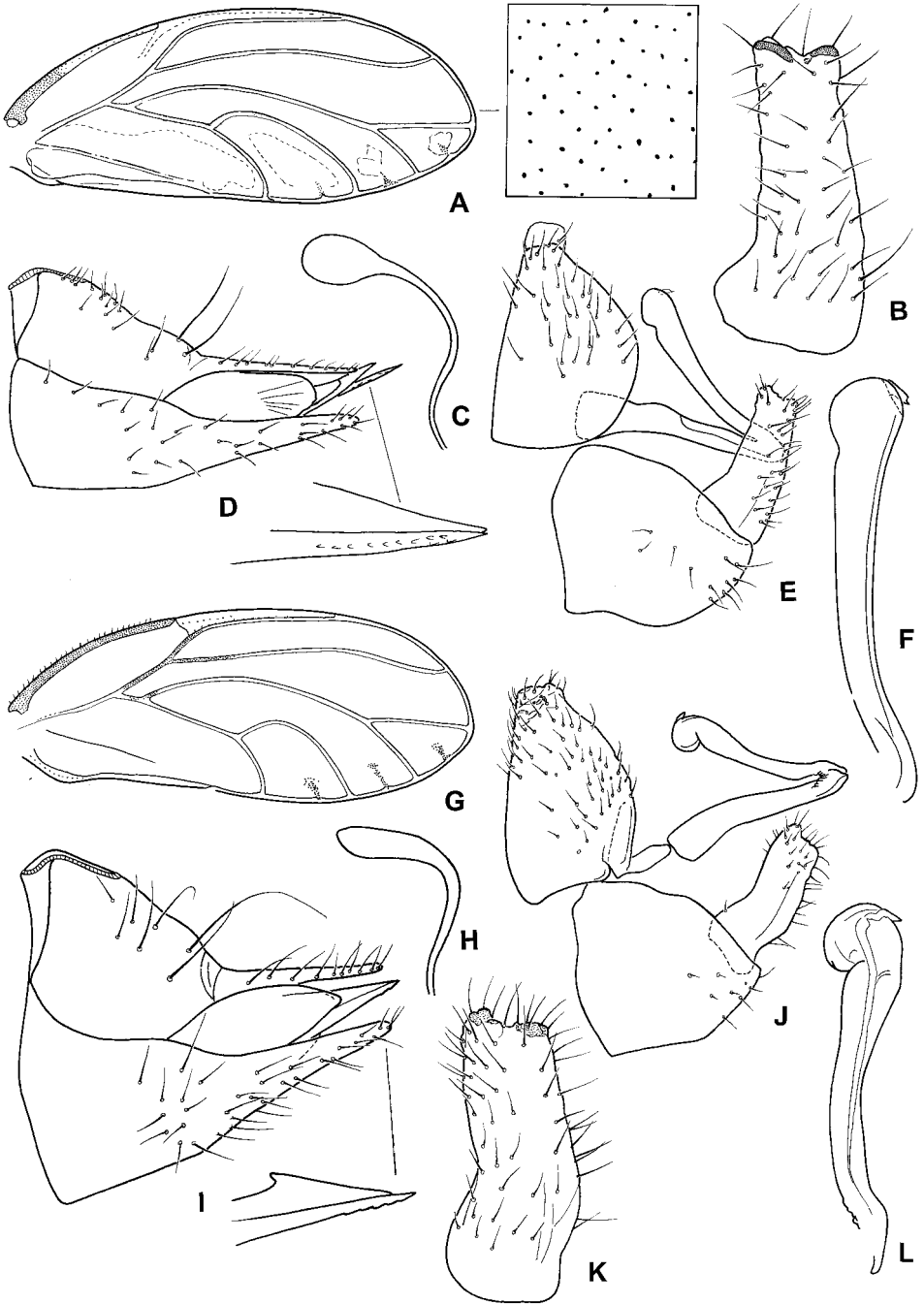

FIG. 8. *Calophya* spp.: A–F, *C. patagonica*; G–L, *C. rubra*. A, G, forewing; B, K, paramere, inner face; C, H, spermatheca; D, I, female genitalia, in profile; E, J, male genitalia, in profile; F, L, distal segment of aedeagus.

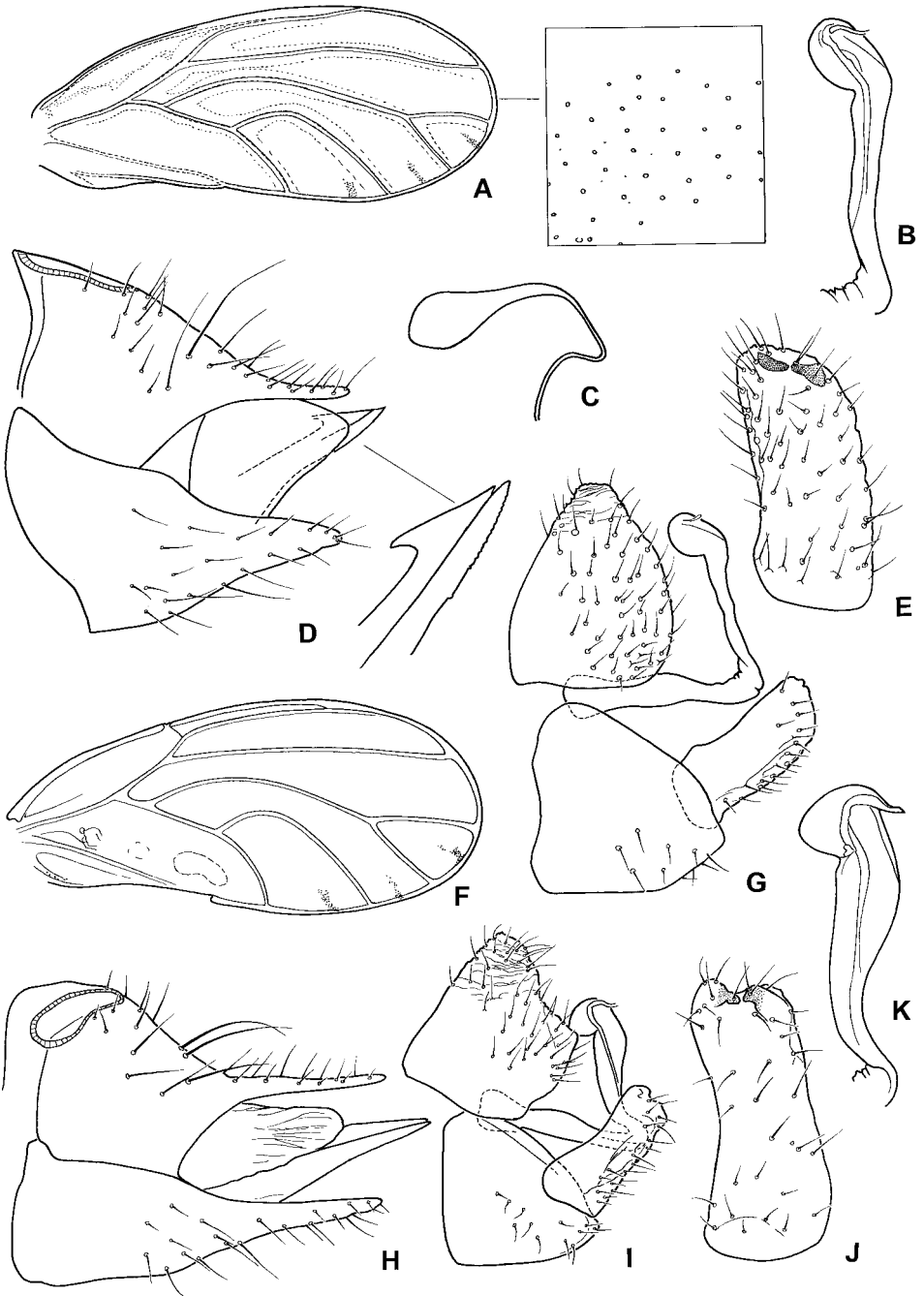

FIG. 9. *Calophya* spp.: A-E, G, *C. schini*; F, H-K, *C. scrobicola*. A, F, forewing; B, K, distal segment of aedeagus; C, spermatheca; D, H, female genitalia, in profile; E, J, paramere, inner face; G, I, male genitalia, in profile.

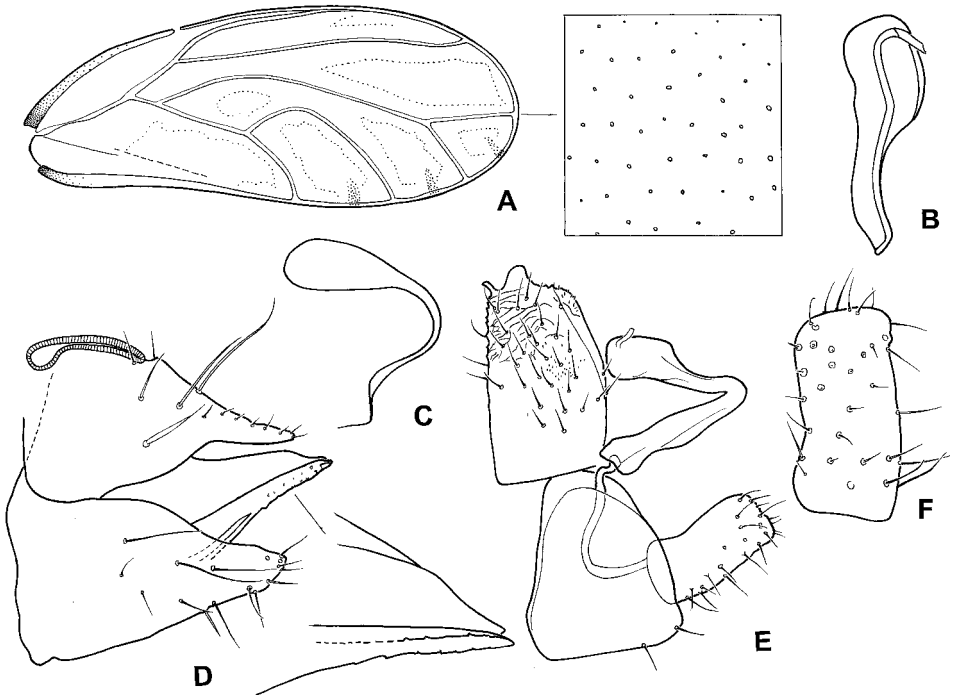

FIG. 10. *Calophya terebinthifolii*: A, forewing; B, distal segment of aedeagus; C, spermatheca; D, female genitalia, in profile; E, male genitalia, in profile; F, paramere, inner face.

apical dilatation. Dorsal margin of female proctiger roundly excavate; subgenital plate pointed apically.

Measurements in mm (9 ♂, 7 ♀). HW 0.51–0.58; AL 0.50–0.63; WL 1.57–2.36; MP 0.13–0.20; PL 0.12–0.15; AA 0.16–0.23; FP 0.33–0.43; VL/GL 0.88–1.20; AL/F1 2.31–3.00; AL/HW 0.93–1.17; WL/HW 3.02–4.07; WL/WW 2.18–2.38; a/b 1.14–1.64; c/d 0.60–0.80; TL/HW 0.68–0.83; MP/HW 0.25–0.35; AB/AA 0.78–1.06; FP/HW 0.65–0.78; FP/SL 1.03–1.27; FP/CL 2.53–3.08; FP/FA 2.17–2.86.

Fifth instar larva (figure 11). Body yellowish with ochreous sclerites. Eyes red. Tips of antennae dark (from material in alcohol). Anterior margin of head weakly concavely rounded, not cleft in the middle. Antenna straight, conical, without sectasetae. Legs with claws. Anterior margin of humeral lobes level with posterior eye margin. Abdominal dorsum with median row of horns. Caudal plate ratio 0.53. Circumanal ring circular. Head margin without setae; wing bud margins with unspecialized setae only; abdominal margin with lanceolate setae.

Host plant, gall and biology. *Schinus montanus*. Nipple gall on the leaf blade along the mid-vein or near the base. On one side the gall is forming a conical nipple with some hairs around the opening channel. On the other leaf face the gall forms a rounded swelling. On emergence of the adult the central part widens and the hairs form a crown around the opening. The gall has one chamber comprising a single larva. A single female was collected on *S. polygamus*, which may be accidental.

Distribution. Argentina (Río Negro), Chile (Regions IV and Metropolitana).

Material examined. HOLOTYPE ♂, Chile: Region Metropolitana, between Corral

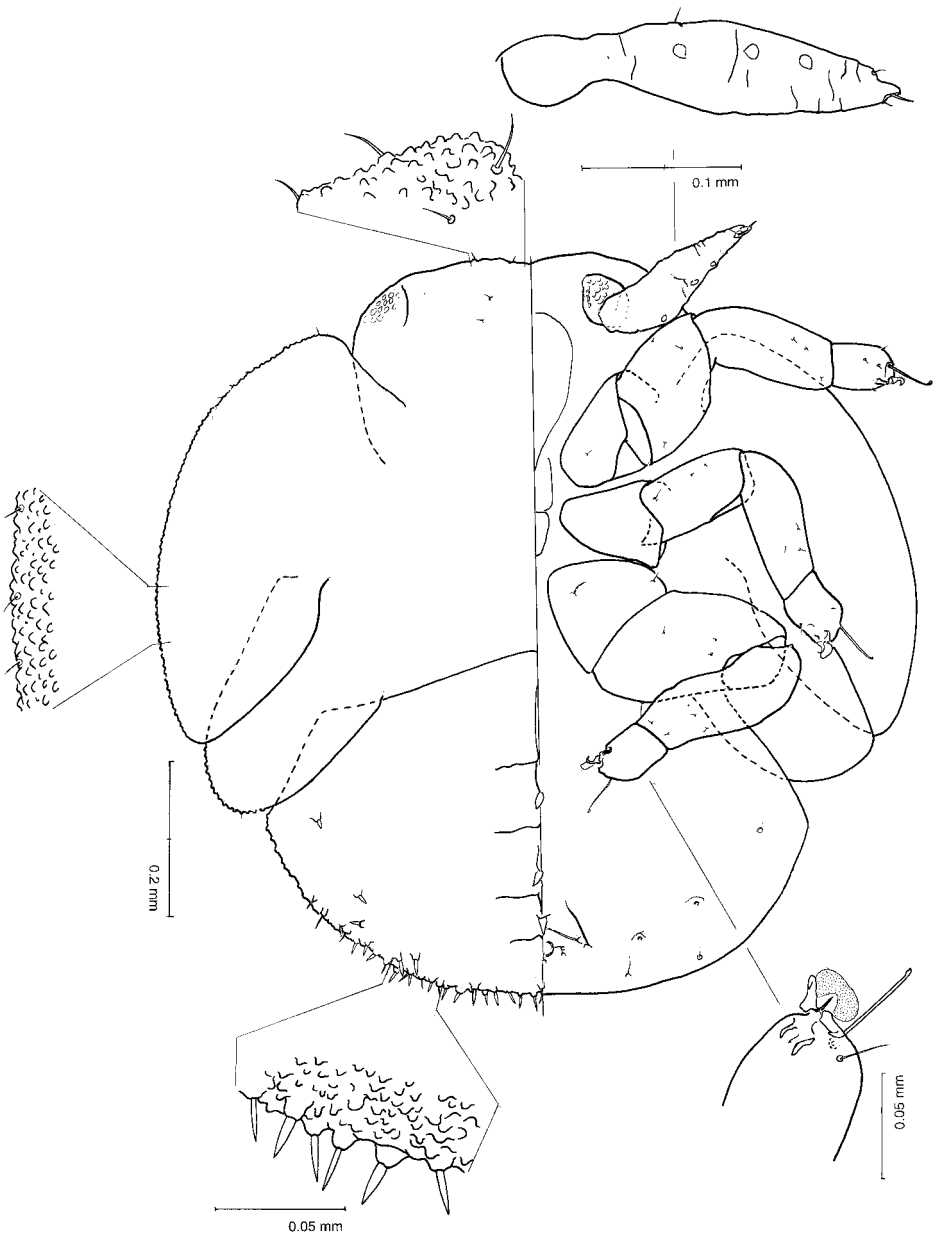

FIG. 11. *Calophya andina*, last instar larva; left dorsal, right ventral face.

Quemado and Farellones, 1700 m, 19.v.1993, *Schinus montanus* (D. Burckhardt), dry mounted (MHNG).

PARATYPES. **Argentina:** 170 adults, Río Negro, El Bolsón, 20.iii.1961, 23.iii.1961, 1.iv.1961, 19.iv.1961, 21.iv.1961 (Topál). **Chile:** 1 ♀, IV Region, Province Limarí, Fray Jorge National Park, 250 m, 7–9.xii.1990, *Schinus polygamus*, mediterranean scrub (D. Agosti and D. Burckhardt); 27 ♂, 24 ♀, 4 larvae, same data as holotype. Dry and slide mounted (BMNH, HNHM, MHNG, MHNS, NHMB, USNM).

***Calophya catillicola* sp. n.**

(figure 4A-E)

Description. Adult. Coloration. Head and thorax dark brown to almost black, shiny. Genal processes in apical half and antennae, except for apical two segments, whitish. Legs dark brown with yellowish tibial apex and basitarsus. Forewings transparent with whitish veins. Abdomen including genitalia greenish to yellowish, strongly contrasting with head and thorax.

Structure. Anterior portion of vertex covered in very short, inconspicuous setae; genal processes long, slender, contiguous in the middle. Forewings (figure 4A) elongate, widest near the middle, angular apically; surface spinules absent, apart from base of cell cu_2 . Genitalia as in figure 4B-E. Male subgenital plate short; proctiger relatively slender, produced posteriorly; paramere lamellar, short with two large apical teeth on the inner face; distal portion of aedeagus short with apical dilatation about half as long as segment. Female proctiger short, clavate in profile, with concave dorsal margin; subgenital plate subacute apically.

Measurements in mm (1 ♂, 1 ♀). HW 0.46–0.47; AL 0.45–0.47; WL 1.52–1.61; MP 0.12; PL 0.08; AA 0.11; FP 0.20; VL/GL 0.88–1.15; AL/F1 2.50–3.36; AL/HW 0.96–1.02; WL/HW 3.30–3.43; WL/WW 2.40–2.41; a/b 1.33–1.43; c/d 0.71–0.76; TL/HW 0.64–0.67; MP/HW 0.26; AB/AA 1.09; FP/HW 0.43; FP/SL 1.11; FP/CL 2.22; FP/FA 2.86.

Fifth instar larva. Anterior margin of head forming two large lobes. Antennae irregularly triangular. Legs without or with strongly reduced claws. Anterior margin of larval humeral lobes ending distal to anterior eye margin. Abdominal dorsum without median row of horns. Caudal plate ratio 0.45. Circumanal ring oval. Head, wing bud and abdominal margins with sectasetae.

Host plant, gall and biology. *Schinus fasciculatus*. Inducing pit galls on the leaves.

Distribution. Argentina (Mendoza).

Material examined. HOLOTYPE ♂, **Argentina**: Province Mendoza, above Villa Vicencia, 50 km NW Mendoza, 1800–2200 m, 18.i.1987, *Schinus fasciculatus* (D. Burckhardt), dry mounted (MHNG).

PARATYPES. **Argentina**: 1 ♂, 1 ♀, same data as holotype; 2 larvae, Mendoza, Mendoza Valley, Punta de Vaca to Uspallata, 1900 m, 16–19.i.1997, in pit galls of *Schinus fasciculatus* (D. Burckhardt); 1 ♀, same data but Uspallata to Potrerillos, 1700 m, 30–31.xii.1995, *Schinus fasciculatus*; 1 ♀, same data but Potrerillos, 1300 m, 17.i.1997; 2 ♀, same data but km 27 Uspallata to Potrerillos, 1500 m, 19.i.1997. Dry and slide mounted (MHNG, NHMB).

Material not included in type series. **Argentina**: pit galls on the leaves, Province Mendoza, Mendoza Valley, Potrerillos, 1300 m, 17.i.1997, *Schinus fasciculatus* (D. Burckhardt); pit galls on the leaves, same data but km 27 Uspallata to Potrerillos, 1500 m, 19.i.1997; pit galls on leaves, same data but Punta de Vaca to Uspallata, 1900 m, 16–19.i.1997; larvae ex pit galls on leaves, same data but above Villa Vicencia, 50 km NW Mendoza, 1800–2200 m, 18.i.1987. Preserved in alcohol (MHNG).

***Calophya clausa* sp. n.**

(figures 4F–K, 12, 57, 58)

Description. Adult. Coloration. Head and body dark brown to black, shiny. Apex of genal processes light. Forewings transparent, veins ochreous to brown, vein

C + Sc almost black. Young specimens with more extended yellow or green coloration.

Structure. Anterior portion of vertex covered in setae which are about as long as distance between them; genal processes long, slender, contiguous in the middle. Forewings (figure 4F) oval, widest in the middle, narrowly irregularly rounded apically; surface spinules, apart from base of cell cu_2 , absent. Genitalia as in figure 4G–K. Male subgenital plate short; proctiger massive; paramere long, obliquely truncate apically; distal portion of aedeagus long with straight, long shaft and short apical dilatation. Dorsal margin of female proctiger angularly excavate; subgenital plate pointed apically.

Measurements in mm (5 ♂, 6 ♀). HW 0.52–0.62; AL 0.54–0.71; WL 1.67–2.33; MP 0.17–0.22; PL 0.13–0.17; AA 0.15–0.17; FP 0.33–0.40; VL/GL 1.00–1.33; AL/F1 2.38–3.33; AL/HW 0.96–1.27; WL/HW 3.21–3.88; WL/WW 2.13–2.48; a/b 1.19–1.61; c/d 0.57–0.95; TL/HW 0.73–0.85; MP/HW 0.33–0.38; AB/AA 1.00–1.13; FP/HW 0.55–0.71; FP/SL 0.80–1.48; FP/CL 2.86–3.27; FP/FA 1.94–2.77.

Fifth instar larva (figure 12). Yellow, dorsal sclerites dark brown, venter ochreous. Anterior margin of head weakly concavely rounded, not cleft in the middle. Antennae straight, without sectasetae. Legs with claws. Anterior margin of humeral lobes ending level with posterior eye margin. Abdominal dorsum with median row of horns. Caudal plate ratio 0.53. Circumanal ring circular. Head and wing bud margins without setae; abdominal margin with lanceolate setae.

Host plants, gall and biology. *Schinus kauselii*, *S. montanus*, *S. patagonicus*. Nipple gall on the leaves (figures 57, 58). On one face with flattened, conical nipple bearing hairs at the top around the opening pore. On the other face weakly convex. The gall has one chamber comprising the single larva. For adult emergence, the gall widens at the opening pore but does not tear as in other species such as *C. mammifex* or *C. rubra* (figure 58).

Distribution. Argentina (Río Negro), Chile (Regions V–VII and IX).

Material examined. HOLOTYPE ♂, **Chile:** VII Region, Province Talca, Gil de Vilches Park, El Enladrillo, Valle El Venado, 1350–1700 m, 14.i.1996, *Schinus patagonicus* (D. Burckhardt), dry mounted (MHNG).

PARATYPES. **Argentina:** 2 ♂, 8 ♀, Río Negro, Bariloche, 5–10.xi.1926 (F. and M. Edwards). **Chile:** V Region, 3 ♂, 1 larva ex nipple gall on leaves, Province Los Andes, 25 km W Portillo, 32°50'S 70°08'W, 1900–2100 m, 1.xii.1993, *Schinus montanus* (D. Burckhardt); 1 ♂, same data but Río Blanco to Portillo, Valle Aconcagua, 2200–2400 m, 23.xi.1992; 4 ♂, 3 ♀, 4 larvae, same data but La Campana National Park, Sector Granizo, from leaf galls of *Schinus montanus* (F. Sáiz); 2 ♂, 1 ♀, 4 larvae, same data but La Campana National Park, Sector Ocoa, 1995, *Schinus montanus*; VII Region, 4 ♂, 8 ♀, 5 larvae ex nipple galls on leaves, same data as holotype; 1 larva ex nipple gall on leaf, same data but sector Piedras Blancas, 1350–1600 m, 12.i.1996, *Schinus kauselii*; IX Region, 2 ♂, 1 ♀, 1 larva ex nipple gall on leaves, same data but Province Malleco, Nahuelbuta National Park, 1300 m, 16–17.xii.1990, *Nothofagus antarctica* forest, *Schinus patagonicus* var. *crenuloides*; 3 larvae ex nipple galls on leaf, same data but Province Cautín, Conguillío National Park, Playa Linda, 1150 m, 19–20.xii.1990, *Nothofagus antarctica* forest, *Schinus patagonicus*; 4 larvae ex nipple galls on leaves, same data but 1100 m, 30.i.1996. Dry and slide mounted (BMNH, MHNG, NHMB, UCVA).

Material not included in type series. **Chile:** V Region; larvae from nipple galls of leaves of *Schinus montanus*, Province Los Andes, 14 km Portillo to Río Blanco,

Aconcagua Valley, 2100 m, 23.xii.1995, subalpine scrub (D. Burckhardt); larvae from nipple galls of leaves of *Schinus montanus*, same data but 19 km Portillo to Río Blanco, 1900 m; larvae from nipple galls of leaves of *Schinus montanus*, same data but Portillo to Río Blanco, 1800 m, 31.xii.1995, mediterranean scrub; nipple galls on the leaves, Aconcagua Valley, Juncal, 33°S, 2200 m, 26.i.1903, *Schinus montanus* (O. Bucktien); nipple galls on the leaves, Province Guillota, La Campana National Park, 1300 m, 11.i.1985 (D. Hollis); VI Region, nipple galls on the leaves of *Schinus kauselii* and *patagonicus*, Province Cochagua, Bellavista, Río Claro, 900 m, 11.i.1996, degraded deciduous forest; VII Region, nipple galls on leaves, same data but Province Talca, Gil de Vilches Park, sector Piedras Blancas, 1350–1600 m, 12.i.1996, *Schinus kauselii* and *patagonicus*; nipple galls on the leaves of *Schinus patagonicus*, same data but sendero El Enladrillado, Valle El Venado, 1350–1700 m, 14.i.1996, mixed *Nothofagus* forest; IX Region, nipple galls on leaves, Province Malleco, Nahuelbuta National Park, 1300 m, 16–17.xii.1990, *Nothofagus antarctica* forest, *Schinus patagonicus* var. *crenuloides* (D. Burckhardt); larvae from nipple galls on the leaves of *Schinus patagonicus*, same data but Tolhuaca National Park, sector Laguna Verde, 1000–1300 m, 27.i.1996, mixed *Nothofagus* and *Nothofagus/Araucaria* forest; nipple galls on leaves, same data but Province Cautín, Conguillío National Park, Playa Linda, 1150 m, 19–20.xii.1990, *Nothofagus antarctica* forest, *Schinus patagonicus*; larvae from nipple galls on the leaves of *Schinus patagonicus*, same data but 1100 m, 30.i.1996, mixed *Nothofagus/Araucaria* forest. Dry or alcohol preserved (BMNH, MHNG).

***Calophya clavuligera* sp. n.**

(figure 13)

Psyllid gall, Rübsaamen, 1908: 77, figure 17. Brazil: (Paraná?) Ipiranga, 21.iii.1905, galls on the leaves of *Schinus* sp. ([sic] probably *Lithrea* sp.) (Usteri) (depository?)

Description. Adult unknown.

Fifth instar larva (figure 13). Yellow, dorsum with brown median streak stretching from apex of head to abdominal tip. Eyes greyish, antennal apices dark brown. Dorsum flattened, disk-shaped, almost circular, sclerotized. Venter membranous, strongly expanded to fit into pit. Anterior margin of head almost straight, weakly, narrowly cleft in the middle. Antennae irregularly triangular, with small, slender sectasetae. Legs with very small claws. Anterior margin of humeral lobes ending distal to anterior eye margin. Abdominal dorsum without median row of horns. Caudal plate ratio 0.55. Circumanal ring oval. Head, wing bud and abdominal margins fringed with very slender sectasetae.

Host plants, gall and biology. *Lithrea brasiliensis* and *molleoides*. Inducing pit galls on the leaves; pit circular in outline with slightly swollen margins which are lighter than surrounding tissue. Galls and larvae have been described by Rübsaamen (1908).

Distribution. Argentina (Catamarca, Cordoba, Corrientes, Misiones, Salta), Bolivia (Santa Cruz), Brazil (Rio Grande do Sul), Paraguay (Caaguazú, Canendiyu), Uruguay (Lavalleja, Rivera, Tacuarembó). The species was reported as unidentified psyllid gall from Brazil (Paraná?) (Rübsaamen, 1908).

Material examined. HOLOTYPE fifth instar larva, **Argentina:** Misiones Province, Rt. 14, 3 km E Centinela, 29.xi.1995, *Lithrea molleoides* (H. A. Cordo), dry mounted (NHMB).

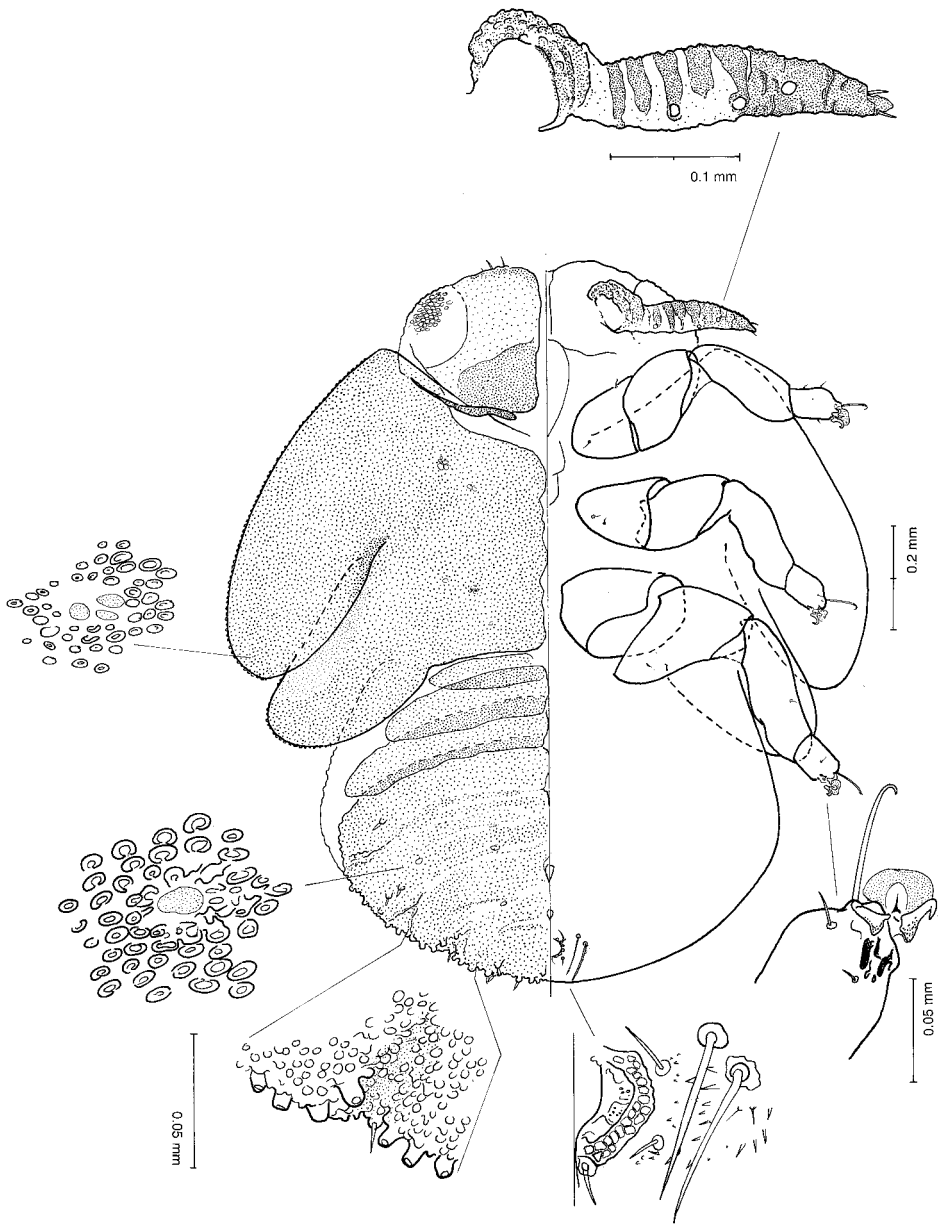

FIG. 12. *Calophya clausa*, last instar larva; left dorsal, right ventral face.

PARATYPES. **Argentina:** 214 larvae, same data as holotype (BMNH, NHMB, SABC, USNM).

Material not included in type series. **Argentina:** pit galls on the leaves, Catamarca, Fuerte de Andalgalá, x.1872, *Lithrea molleoides* (F. Schickendantz); deep pit galls on lower leaf surface, Cordoba, Diquede los Molinos, Sierra, 28.x.1974, *Lithrea molleoides* (Tirel); pit galls on the leaves, Cordoba, Ochoa, Punilla, 17.xi.1902 and 3.x.1904, *Lithrea molleoides* (T. Stuckert); larvae in pit galls on the leaves, Corrientes, Santo Tomé, Ruta 40, Ayo. Chimiray, 12.xi.1974, *Lithrea molleoides* (A. Schinini

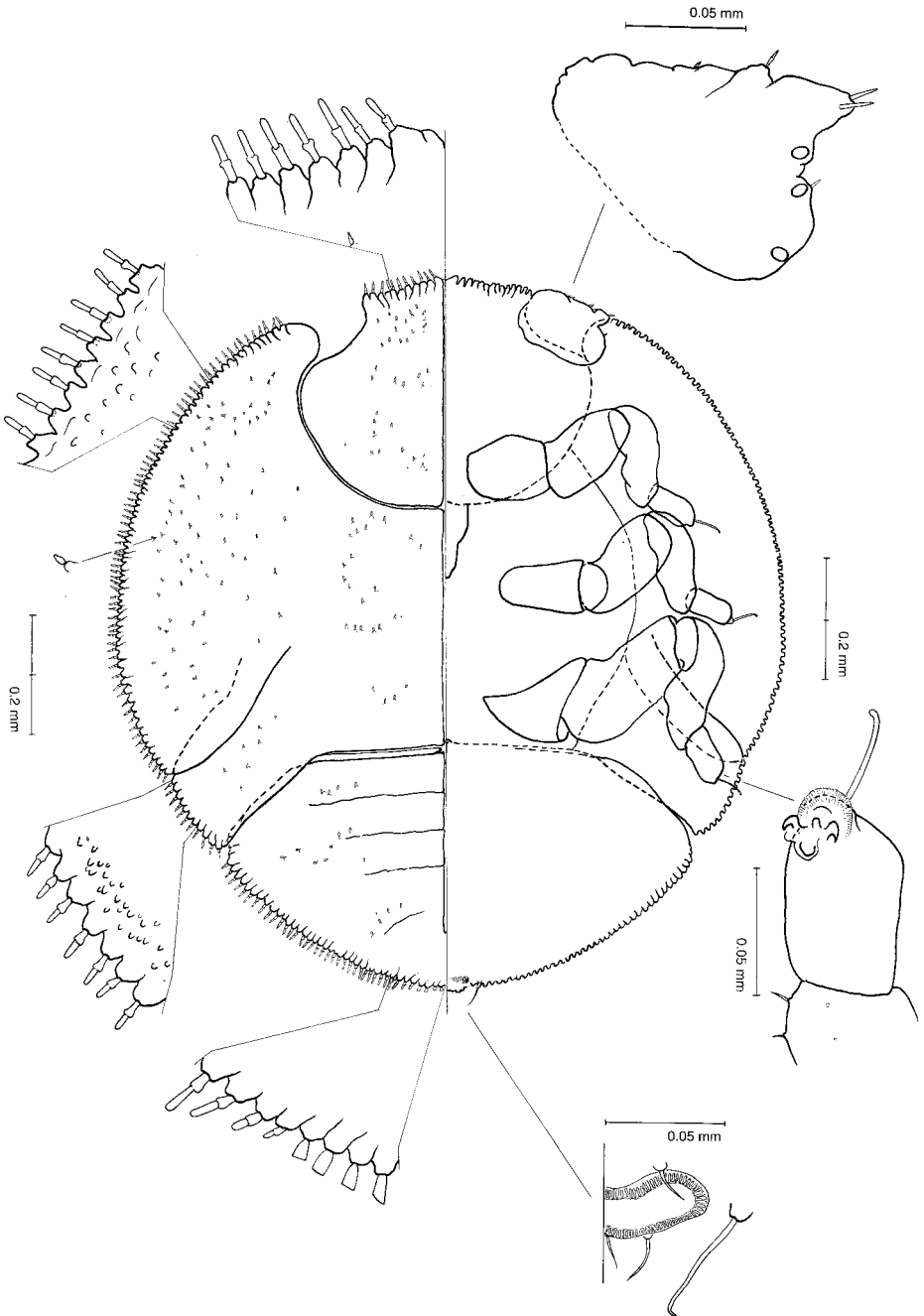

FIG. 13. *Calophya clavuligera*, last instar larva; left dorsal, right ventral face.

and R. Carnevali); pit galls on the leaves, Corrientes, Ituzaingó, Isla Apipé Grande, Puerta Mora, 11.xii.1973, *Lithrea molleoides* (A. Kapovickas *et al.*); leaves of *Lithrea molleoides* with pit galls and larvae, Misiones, same data as holotype; pit galls on the leaves, Misiones, Iguazú, Puerte Esperanza, 12 km, 16.x.1950, *Lithrea molleoides*

(J. E. Montes); deep pit galls on the leaves, Salta, Guachipas, Cuesta del Lajar, along road, 1850 m, 27.x.1991, *Lithrea molleoides* (A. Charpin). **Bolivia:** larvae in pit galls on the leaves, Santa Cruz, Samaipata, 19.x.1928, 1600 m, *Lithrea molleoides*, mountain forest (J. Steinbach). **Brazil:** deep pit galls on the leaves, Rio Grande do Sul, Caxias do Sul, Ana Rech, Faxinal, 700 m, 9.xi.1988, *Lithrea brasiliensis* (R. Wasum *et al.*); pit galls on the leaves, Belém Vélho, Arraial da Gloria, 31.x.1897, *Lithrea molleoides*. **Paraguay:** deep pit galls on the leaves and larvae, Canendiyu, Sierra de Marayú, road to Yerbales, near San Estanislao, 24°39'S 56°26'W, *Lithrea molleoides* (E. Hassler); deep pit galls on the leaves, Caaguazú, San José, 25°33'S 56°45'W, in the fields, 9.xi.1882, *Lithrea molleoides* (B. Balansa). **Uruguay:** pit galls on the leaves, Lavalleja, Minas, 34°23'S 55°14'W, Penitente, 200 m, 1–2.xi.1931, *Lithrea molleoides*; pit galls on the leaves, Rivera, 30°54'S 55°31'W, Galgo, 250–300 m, 2–4.xii.1933, *Lithrea molleoides* (W. G. Herter); pit galls on the leaves, Tacuarembó, 31°44'S 55°59'W, x.1895, *Lithrea molleoides* (Arechavaleta). Preserved dry and in alcohol (CJBG, NHMB, SABC).

Calophya duvauae (Scott)

(figure 5A–F)

Psylla duvauae Scott, 1882: 443. Lectotype ♂, Argentina: Buenos Aires, *Duvaua dependens*, Scott coll. 1888.11 (BMNH), designated by Burckhardt, 1988

Holotrioza duvauae (Scott); Brèthes, 1920: 133

Calophya duvauae (Scott); Burckhardt, 1988: 123

Calophya williamsoni Lizer, 1943: 163. Holotype ♂, Argentina: La Pampa, General Pico, x.1941, *Schinus polygamus* f. *arenicola* (J. Williamson), synonymized with *C. duvauae* by Burckhardt, 1988

Psyllid gall, Manganaro, 1914: 148. Argentina: Buenos Aires, Botanical Garden of the Faculty of Agriculture and Isla Santiago, galls on the leaves of *Schinus polygamus* (depository?)

Description. Adult. Coloration. No material available.

Structure. Anterior portion of vertex covered in very conspicuous setae which are longer than distance between them; genal processes broadly rounded, very short. Forewings (figure 5A) oval, evenly, broadly rounded apically; surface spinules present at wing base and along outer wing margin covering small areas. Genitalia as in figure 5B–F. Male subgenital plate short; proctiger thick, produced posteriorly; paramere long with two large apical teeth on the inner face; distal portion of aedeagus long with apical dilatation about half as long as segment. Dorsal margin of female proctiger roundly excavate, process relatively short; subgenital plate subacute apically.

Measurements in mm (1 ♂, 1 ♀). HW 0.61–0.65; AL 0.66–0.85; WL 1.94–1.97; MP 0.22; PL 0.17; AA 0.18; FP 0.38; VL/GL 2.50–3.25; AL/F1 2.06–2.74; AL/HW 1.08–1.31; WL/HW 3.03–3.18; WL/WW 2.14–2.16; a/b 0.74–1.33; c/d 0.71–1.03; TLW 0.89–0.92; MP/HW 0.34; AB/AA 1.06; FP/HW 0.62; FP/SL 1.41; FP/CL 3.17; FP/FA 2.71.

Fifth instar larva. Anterior margin of head weakly concavely rounded, not cleft in the middle. Antennae straight, without sectasetae. Legs with claws. Anterior margin of humeral lobes level with posterior eye margin. Abdominal dorsum without median row of horns. Caudal plate not visible, circumanal ring probably oval. Head, wing bud and abdominal margins without specialized setae; entire body covered in long setae.

Host plant, gall and biology. *Schinus fasciculatus*. Inducing large hemispherical

galls on the lower leaf face which are situated near the mid-vein (Scott, 1882; Jhering, 1885; Houard, 1933). The larvae at hand were all parasitized by Hymenoptera; a high degree of parasitization was also observed by Jhering (1885).

Distribution. Argentina (Buenos Aires) (Scott, 1882; Hieronymus, 1884; Brèthes, 1920; Wille, 1926; Lizer, 1943; Lizer and Molle, 1945; Burckhardt, 1988), Brazil (Rio Grande; Porto Alegre, Pedras blancas, right bank of Guahyba river) (Jhering, 1885; Costa Lima, 1942; Burckhardt, 1988), Uruguay (Burckhardt, 1988). The species was reported as unidentified psyllid gall from Argentina (Buenos Aires, Isla Santiago) (Manganaro, 1914). The record from Chile: Banda Oriente [sic] by Burckhardt (1988) is erroneous and probably concerns Banda Oriental in Uruguay.

Material examined. **Uruguay:** 1 ♂, 1 ♀, parasitized larval skins and galls on *Schinus fasciculatus* without further data (MHNG, NHMW).

Comment. All larval material at hand is parasitized, and some of the characters are not observable (caudal plate, circumanal ring).

Calophya floricola sp. n.

(figure 5G–K)

Description. Adult. Coloration. Greenish to yellowish; head pale yellowish; antennae greyish with brown apex. Legs dirty yellowish with greyish brown tarsi. Forewings transparent with greyish veins. Apices of female genitalia brown.

Structure. Anterior portion of vertex covered in long, conspicuous setae; genal processes long, slender, separated in the middle. Forewings (figure 5K) narrowly elongate, evenly, narrowly rounded apically; surface spinules, apart from base, absent. Genitalia as in figure 5H–K. Male subgenital plate elongate; paramere slender, styliform with a few very long setae at base; distal portion of aedeagus long, gradually widening towards apex. Dorsal margin of female proctiger roundly excavate; subgenital plate subacute apically.

Measurements in mm (3 ♂, 3 ♀). HW 0.68–0.71; AL 0.64–0.75; WL 2.19–2.45; MP 0.23–0.26; PL 0.26–0.30; AA 0.21–0.24; FP 0.45–0.51; VL/GL 1.20–1.62; AL/F1 1.94–2.47; AL/HW 0.93–1.04; WL/HW 3.22–3.45; WL/WW 2.50–2.67; a/b 1.58–2.04; c/d 1.02–1.39; TL/HW 0.71–0.80; MP/HW 0.33–0.38; AB/AA 1.17–1.29; FP/HW 0.66–0.73; FP/SL 1.02–1.10; FP/CL 3.19–3.57; FP/FA 2.65–2.78.

Fifth instar larva, gall and biology unknown.

Host plant. Adults have been collected on flowers of *Schinus molle*.

Distribution. Chile (Region I), Peru (Tacna).

Material examined. HOLOTYPE ♂, **Chile:** Region I, Province Tarapacá, Parcelas de Chaca, 1.xi.1993, on flowers of *Schinus molle* (J. E. Barriga), dry mounted (MHNS).

PARATYPES. **Chile:** 7 ♂, 9 ♀, same data as holotype. **Peru:** 1 ♀, Tacna, Calientes, 10.ii.1994 (L. E. Peña). Dry and slide mounted (MHNG, MHNS, NHMB).

Comment. The species differs from other species by the presence of very long setae on the vertex, by the elongate male subgenital plate and the styliform parameres.

Calophya gallifex (Kieffer and Jörgensen), stat. rev.

(figures 6A–E, 14)

Trioza (?) *gallifex* Kieffer and Jörgensen, 1910: 386. Syntypes galls and larvae, Argentina,

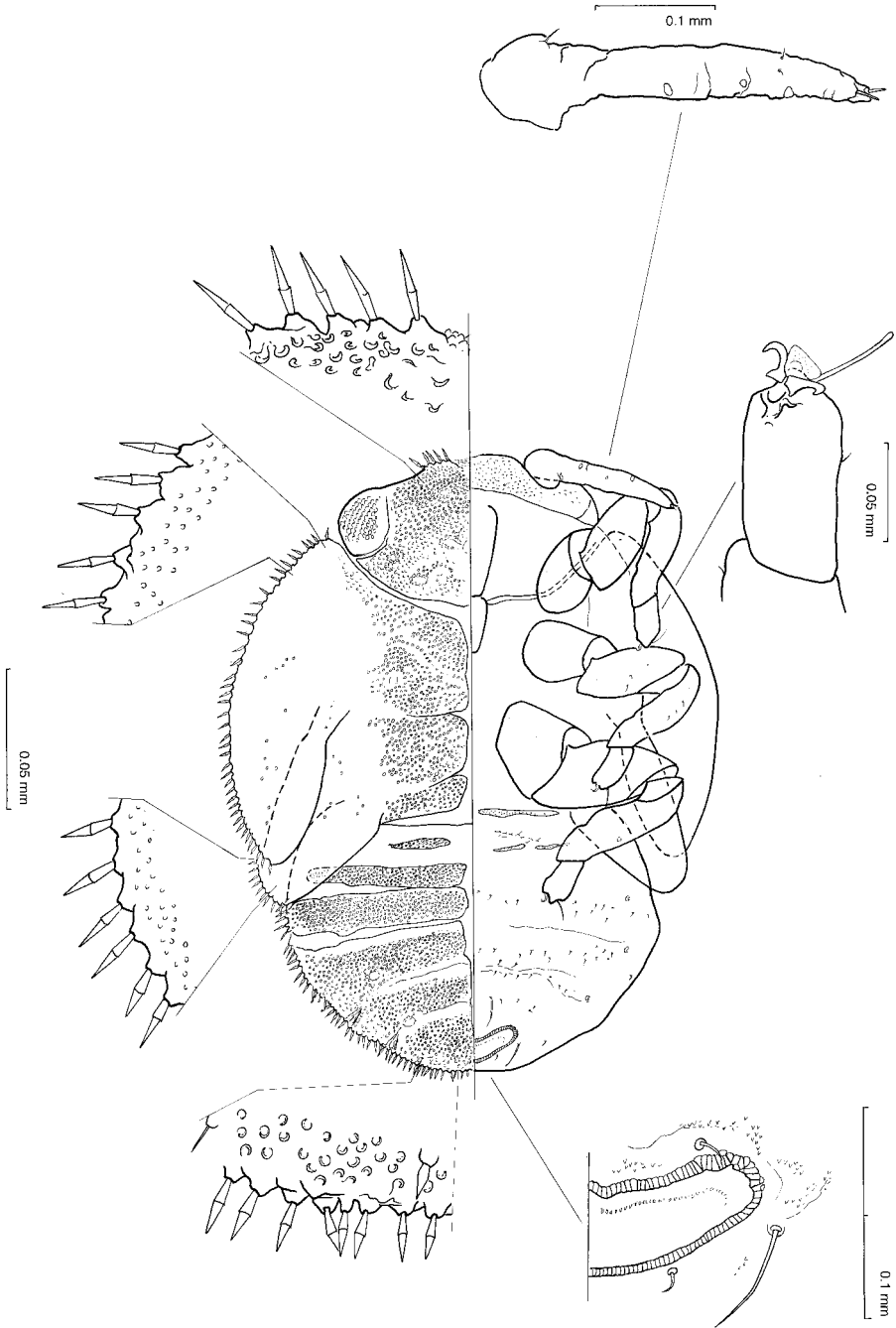

FIG. 14. *Calophya gallifex*, last instar larva; left dorsal, right ventral face.

Cordilleras of Mendoza, iv-x., *Schinus dependens* (Jörgensen), destroyed; Jörgensen, 1917: 5

Calophya gallifex (Kieffer and Jörgensen); Lizer, 1943: 159

Description. Adult. Coloration. Head and thorax ochreous dorsally with reddish

or brown pattern, ventrally dark brown. Apices of genal processes and antennal tips dark brown. Legs ochreous, apical tarsal segments dark brown. Forewings transparent, veins brown. Abdomen dark brown, intersegmental membrane light.

Structure. Anterior portion of vertex covered in short setae which are about as long as distance between them; genal processes long, slender, separated in the middle. Forewings (figure 6A) oval, evenly, broadly rounded apically; surface spinules, apart from base, absent. Genitalia as in figure 6B–E. Male subgenital plate short; proctiger slender; paramere stout; distal portion of aedeagus long with weakly curved shaft and short, slightly elongate apical dilatation. Dorsal margin of female proctiger roundly excavate; subgenital plate subacute apically.

Measurements in mm (2 ♂, 2 ♀). HW 0.46–0.50; AL 0.44–0.53; WL 1.69–1.75; MP 0.17; PL 0.11–0.12; AA 0.13–0.14; FP 0.25–0.26; VL/GL 0.76–0.94; AL/F1 2.32–2.68; AL/HW 0.94–1.06; WL/HW 3.42–3.80; WL/WW 2.27–2.73; a/b 1.35–1.56; c/d 0.83–0.86; TL/HW 0.66–0.72; MP/HW 0.34–0.46; AB/AA 1.00–1.08; FP/HW 0.52–0.54; FP/SL 0.96–1.00; FP/CL 2.50–2.89; FP/FA 2.00–2.50.

Fifth instar larva (figure 14). Straw-coloured, intersegmental membranes lighter. Eyes brown. Anterior margin of head weakly concavely rounded, forming two shallow lobes. Antennae straight, without sectasetae. Legs with claws. Anterior margin of humeral lobes level with posterior eye margin. Abdominal dorsum without horns. Caudal plate ratio 0.45. Circumanal ring oval. Head, wing bud and abdominal margins with sectasetae.

Host plant, gall and biology. *Schinus fasciculatus*. Forming conical galls situated at the leaf margins (Kieffer and Jörgensen, 1910; Burckhardt, pers. obs.). Kieffer and Jörgensen (1910) and Jörgensen (1917) provide a description and illustrations of the gall.

Distribution. Argentina (Mendoza). Reported from the Cordillera of Mendoza (Kieffer and Jörgensen, 1910; Jörgensen, 1917). The records from the Buenos Aires Region may concern another species (see comments).

Material examined. **Argentina:** 1 ♀, Mendoza Province, Mendoza Valley, Uspallata to Potrerillos, 1700 m, 30–31.xii.1995, *Schinus fasciculatus* (D. Burckhardt); 2 ♂, 5 ♀, same data but Potrerillos, 1500 m, 31.xii.1995; 2 larvae, many galls, same data but 1300 m, 17.i.1997; 1 larva, ex gall, same data but Villa Hodel, 7 km Cacheuta to Mendoza, 1100 m, 17.i.1997; 1 ♂, same data but above Villa Vicencia, 50 km NW Mendoza, 1800–2200 m, 18.i.1997; 1 ♂, 1 ♀, Mendoza, Zoological Garden, vii.1997 (S. Roig). Dry and slide mounted (MHNG, NHMB).

Comments. The records of *C. gallifex* from Argentina: Buenos Aires by Tavares (1915), Lizer (1943) and Lizer and Molle (1945) are questionable. There are two females in the USNM from Lizer's material. They are not conspecific with specimens from Mendoza and may represent an undescribed species. Manganaro (1919) described a leaf gall on *Schinus polygamus* from La Plata which is probably produced by Lizer's species.

Calophya hermicitae sp. n.

(figures 6F–K, 15, 59)

Description. Adult. Coloration. Head and thorax dark brown to almost black, shiny. Genal processes, antennae and legs whitish to yellowish, metacoxae and metafemora sometimes light brown. Forewings brown at base, remainder transparent

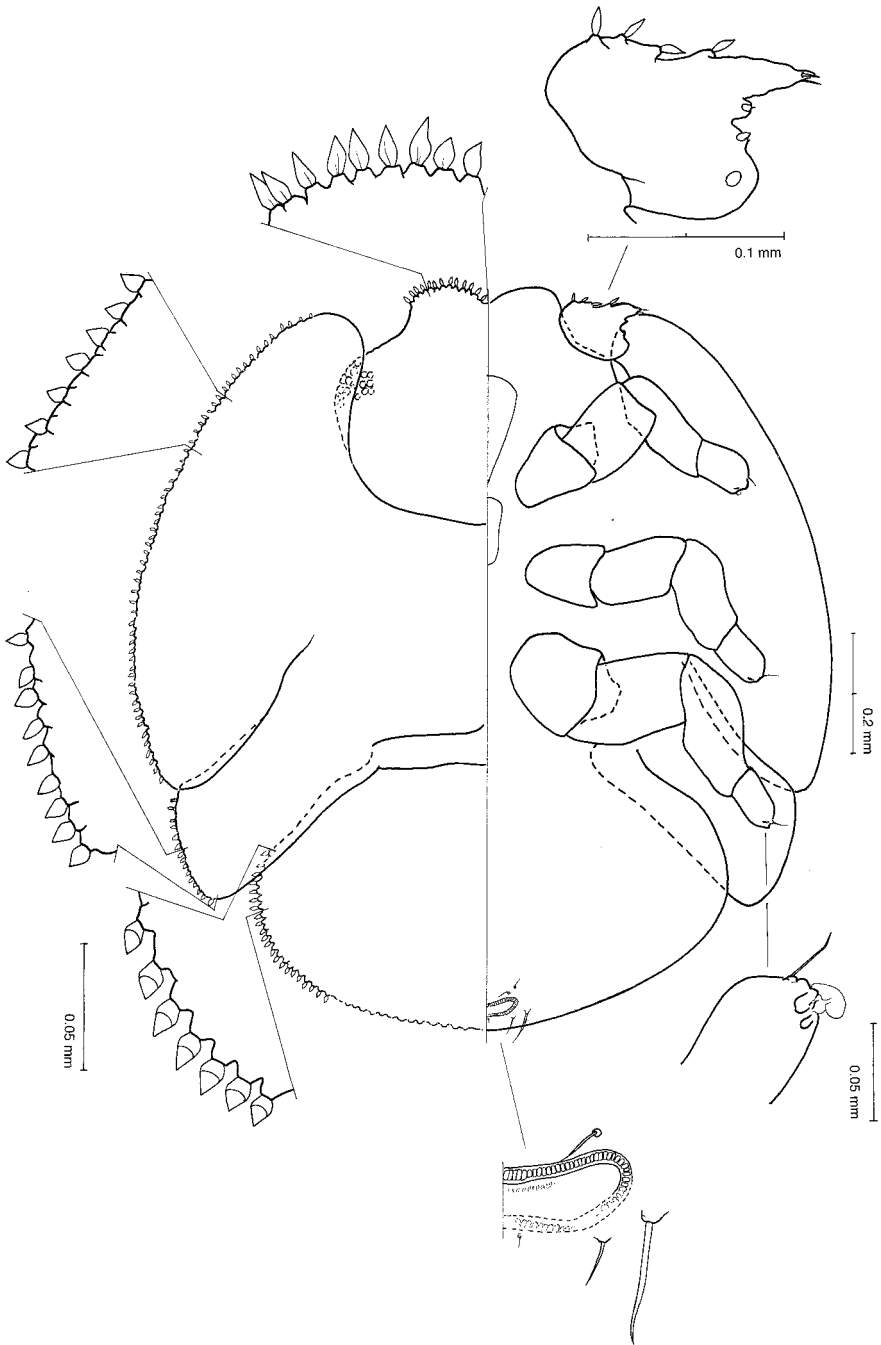

FIG. 15. *Calophya hermiticae*, last instar larva; left dorsal, right ventral face.

or weakly yellowish; veins light yellowish. Abdomen including genitalia greenish to yellowish, strongly contrasting with head and thorax.

Structure. Anterior portion of vertex covered in very short, inconspicuous setae; genal processes long, slender, contiguous in the middle. Forewings (figure 6F)

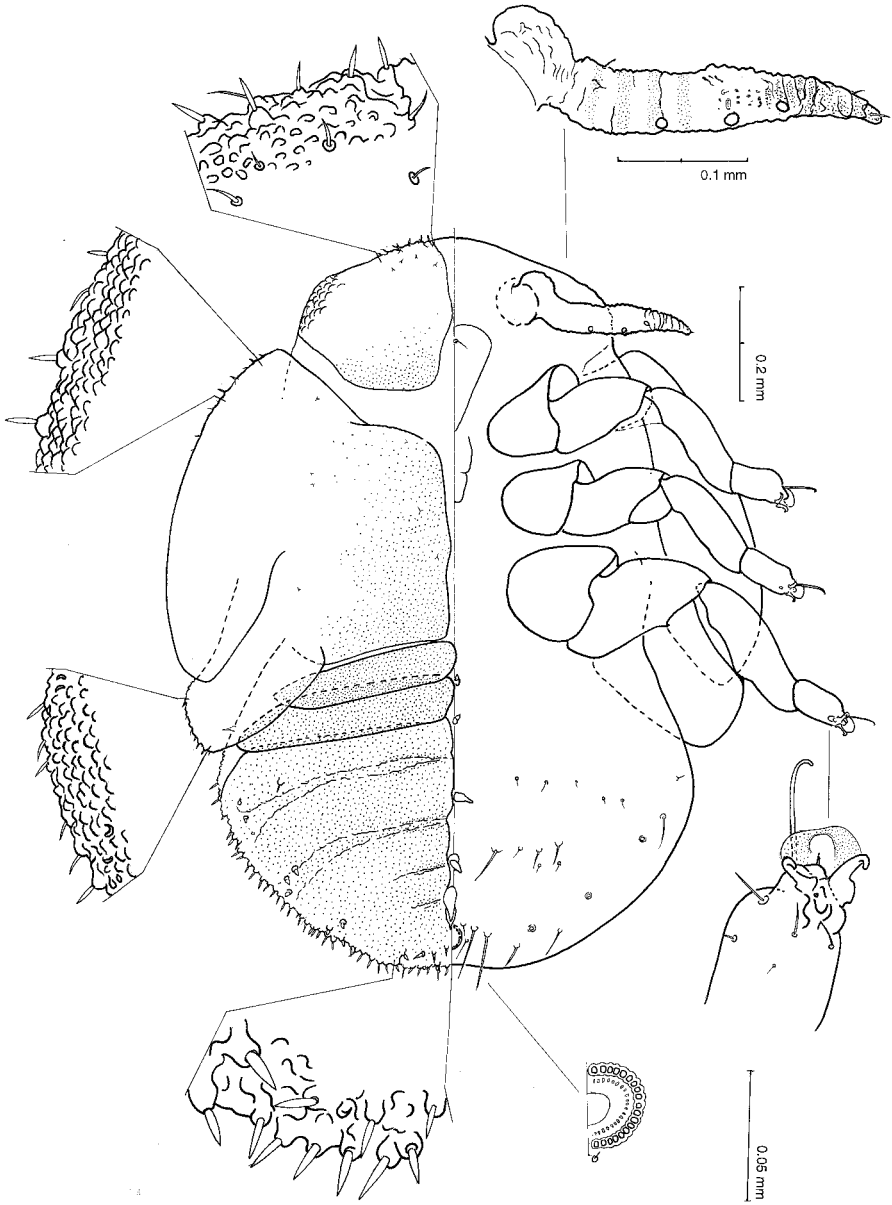

FIG. 16. *Calophya mammifex*, last instar larva; left dorsal, right ventral face.

oblong-oval, subangular apically; surface spinules present in all cells, leaving broad, spinule-free stripes along the veins, sometimes reduced to just a few. Genitalia as in figure 6G–K. Male subgenital plate short; proctiger thick; paramere lanceolate with two apical teeth on the inner face which are close together; distal portion of aedeagus short with large apical dilatation. Female proctiger short, clavate in profile; subgenital plate truncate apically.

Measurements in mm (3 ♂, 3 ♀). HW 0.49–0.55; AL 0.45–0.56; WL 1.54–1.82; MP 0.13–0.20; PL 0.18–0.19; AA 0.09–0.11; FP 0.19–0.22; VL/GL 1.00–1.50; AL/F1

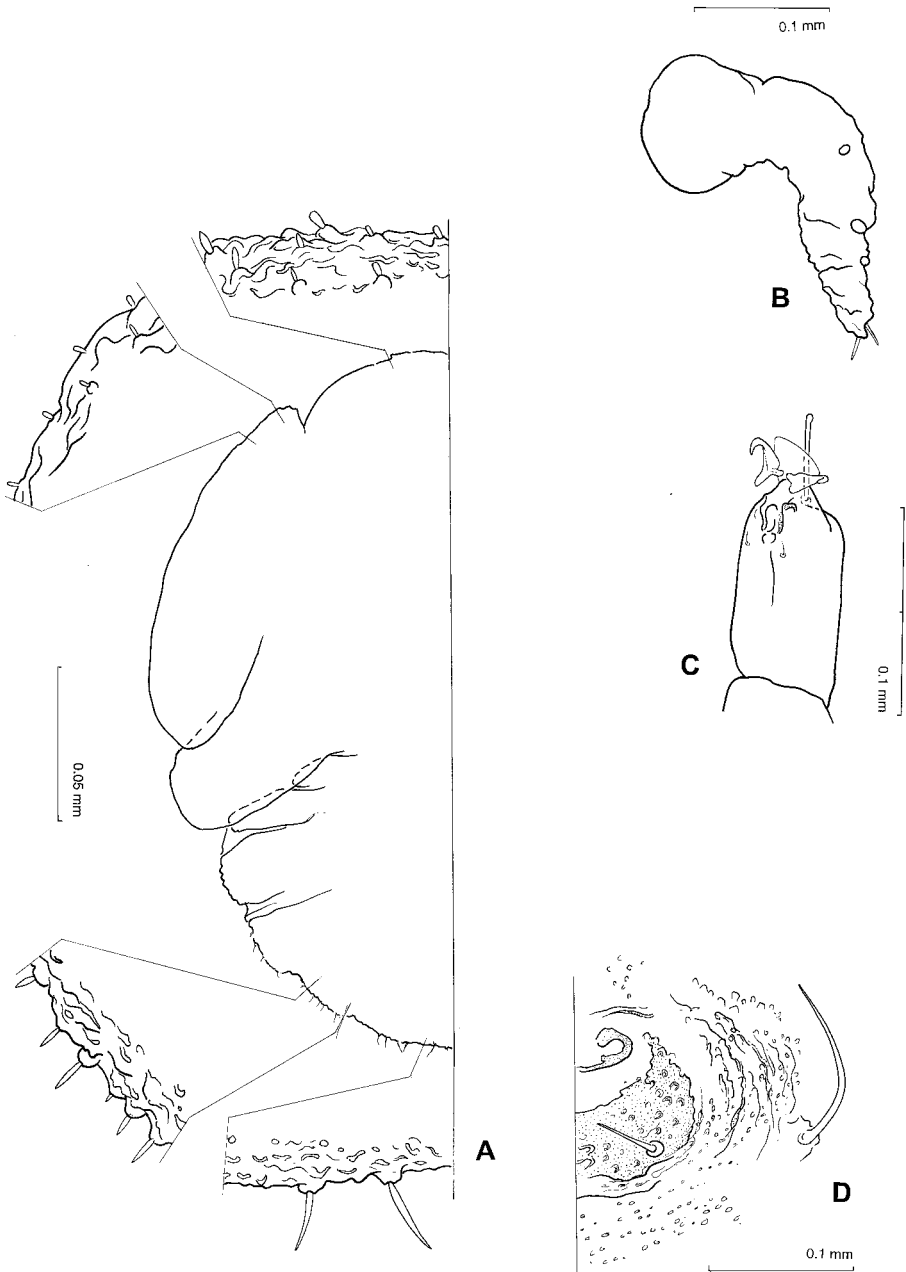

FIG. 17. *Calophya orbicola*, last instar larva: A, outline of body; B, antenna, C, tarsus; D, anal region.

2.70–3.06; AL/HW 0.94–1.02; WL/HW 3.14–3.50; WL/WW 2.26–2.62; a/b 1.23–1.45; c/d 0.74–0.87; TL/HW 0.55–0.67; MP/HW 0.33–0.37; AB/AA 1.09–1.44; FP/HW 0.39–0.45; FP/SL 1.36–1.57; FP/CL 2.11–2.75; FP/FA 3.67–5.50.

Fifth instar larva (figure 15). Orange. Anterior margin of head forming two large lobes. Antennae S-shaped, with sectasetae. Legs without or with strongly reduced

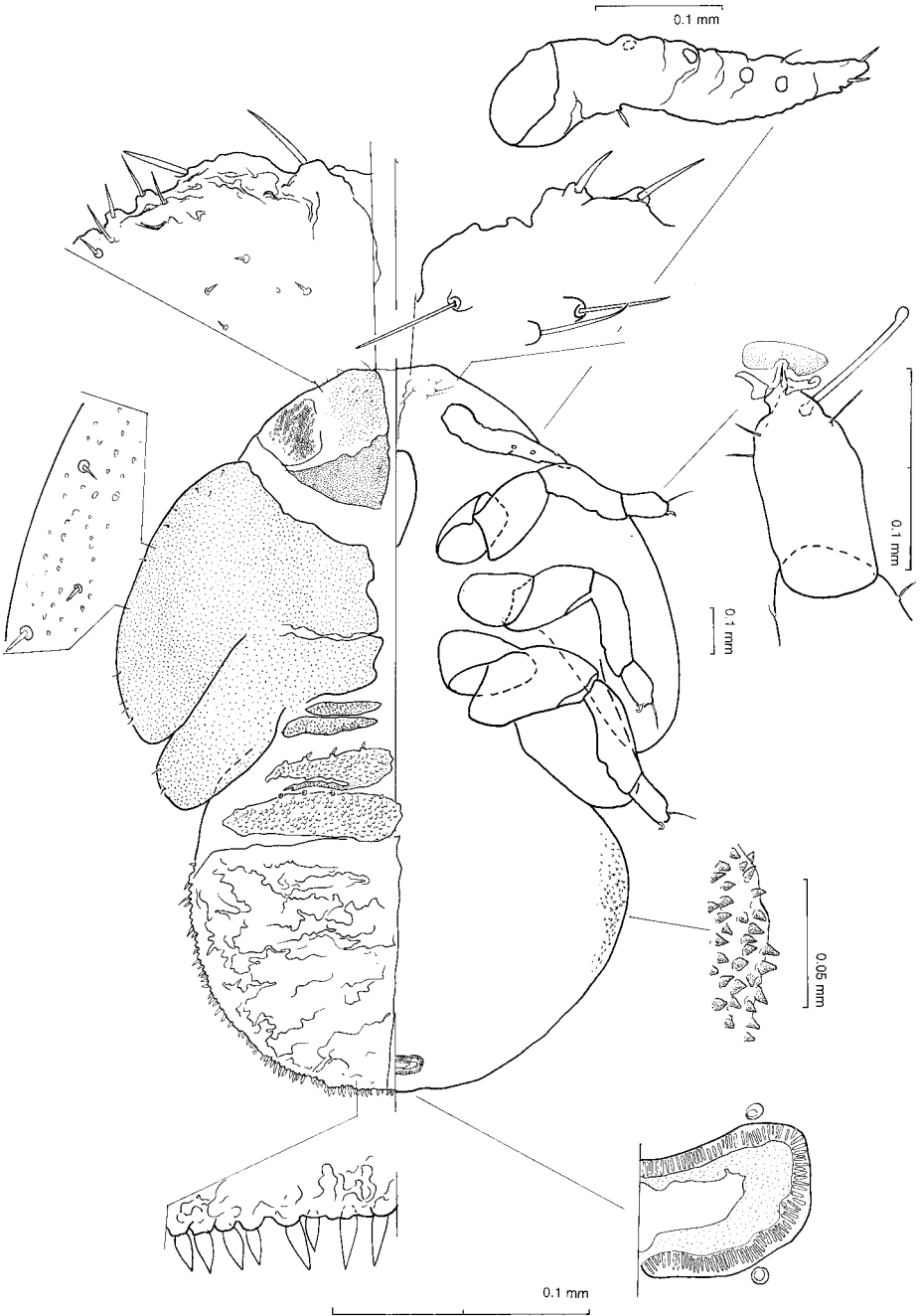

FIG. 18. *Calophya patagonica*, last instar larva; left dorsal, right ventral face.

claws. Anterior margin of humeral lobes ending distal to anterior eye margin. Abdominal dorsum without median row of horns. Caudal plate ratio 0.46. Circumanal ring oval. Head, wing bud and abdominal margins with sectasetae.

Host plants, gall and biology. *Schinus montanus* and *patagonicus*. Inducing pit

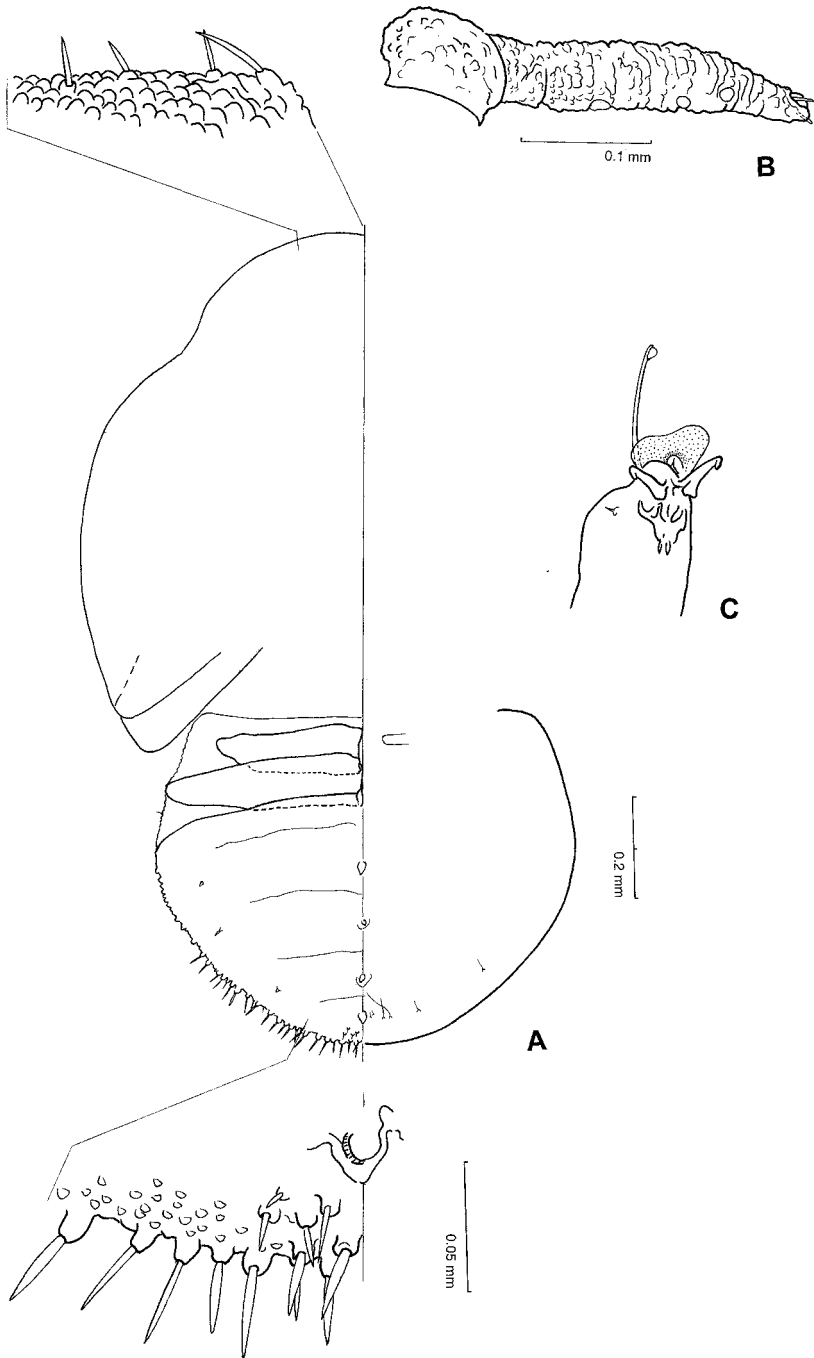

FIG. 19. *Calophya rubra*, last instar larva: A, outline of body; B, antenna, C, apex of tarsus.

galls on the leaves. The gall was described and illustrated by Nuñez and Sáiz (1994, nr 50-1, figure 21).

Distribution. Chile (Regions V, VII and IX).

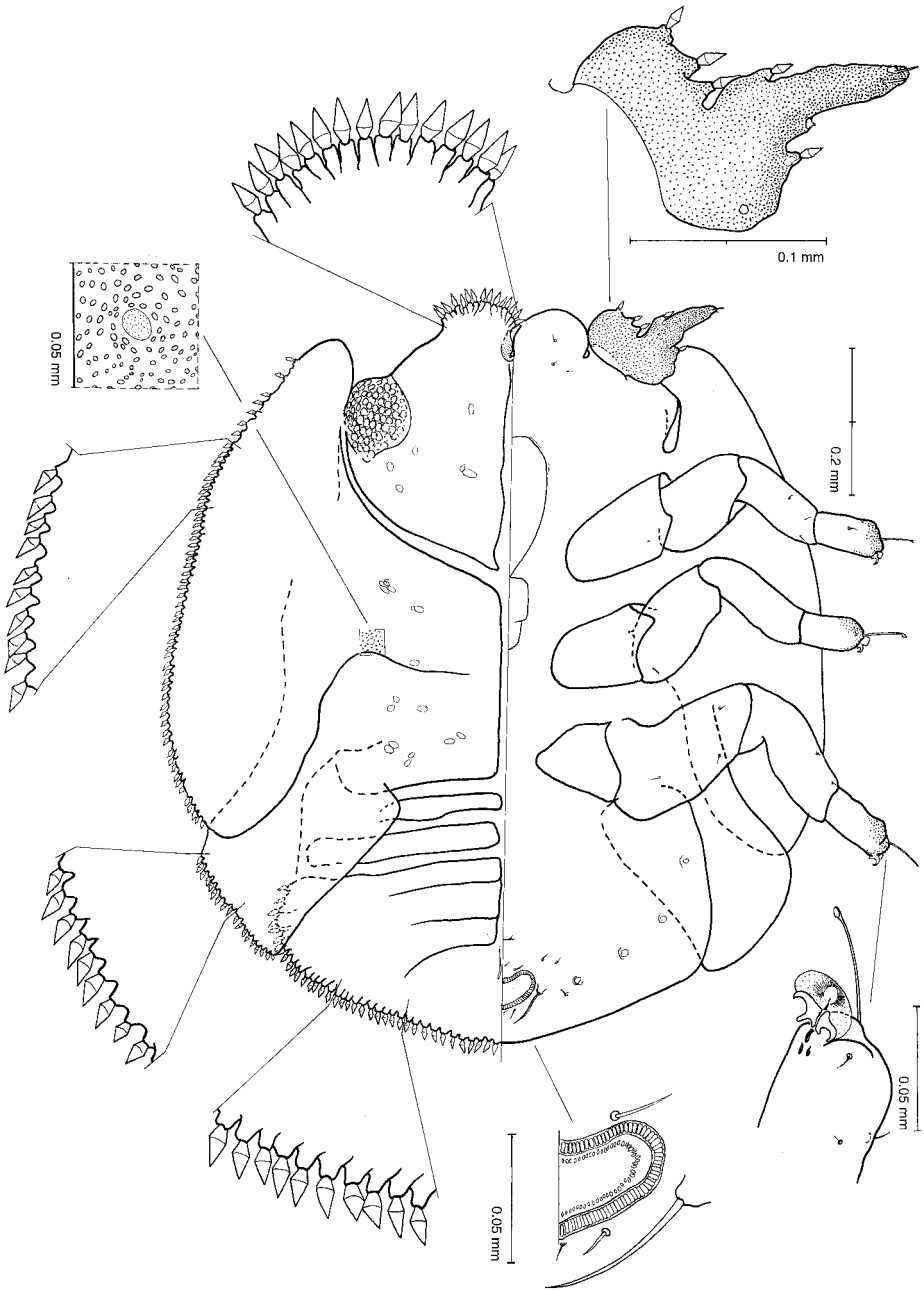

FIG. 20. *Calophya schini*, last instar larva; left dorsal, right ventral face.

Material examined. HOLOTYPE ♂, **Chile:** V Region, Province Los Andes, 25 km W Portillo, 32°50'S 70°08'W, 1900–2100 m, 1.xii.1993, *Schinus montanus* (D. Burckhardt), dry mounted (MHNG).

PARATYPES. **Chile:** V Region, 7 ♂, 12 ♀, 3 larvae, same data as holotype; 1 ♂, 4 ♀, same data but Río Blanco to Portillo, Valle Aconcagua, 2200–2400 m, 23.xi.1992; IX Region, 1 ♀, Province Malleco, Tolhuaca National Park, sector Laguna Verde,

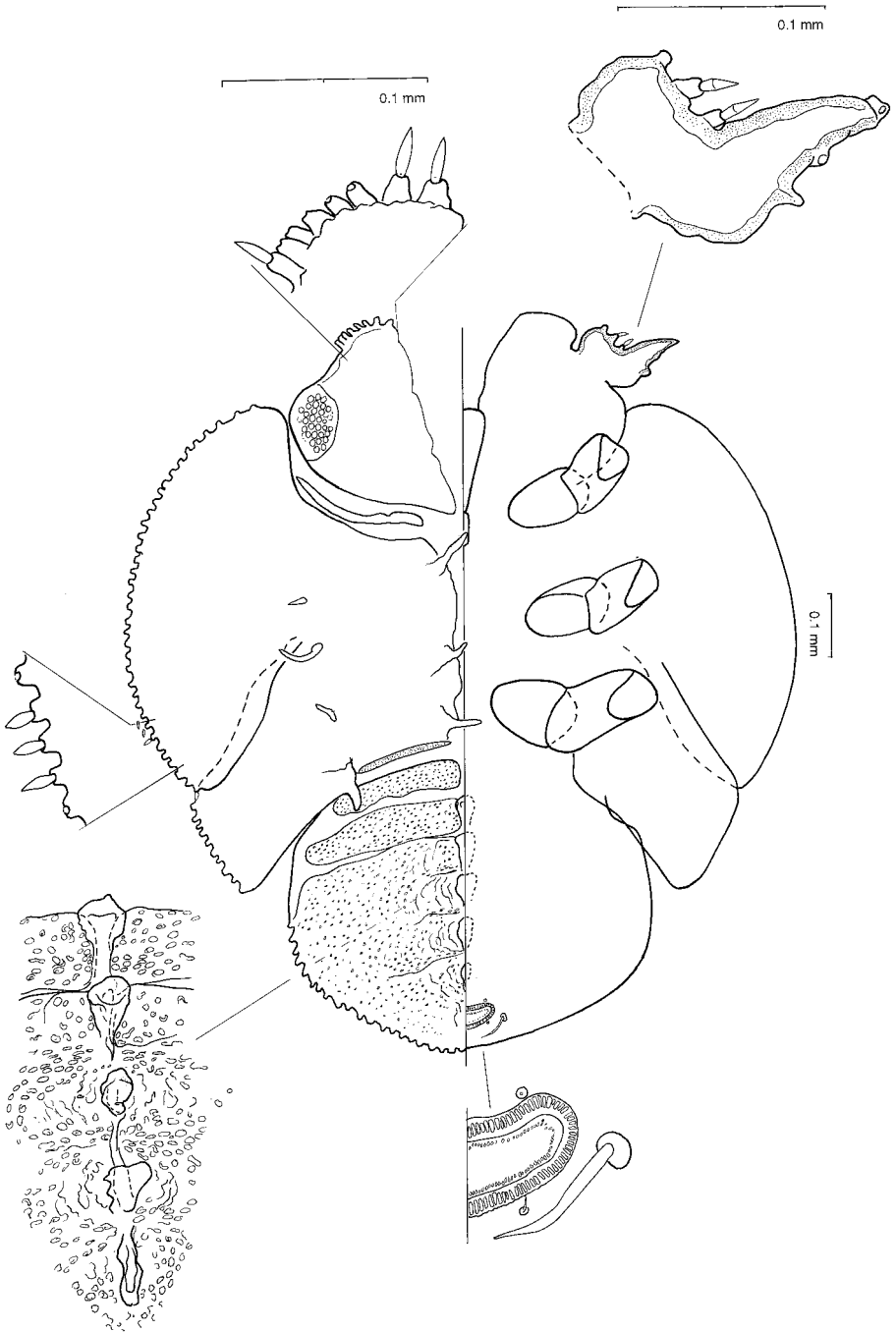

FIG. 21. *Calophya scrobicola*, last instar larva; left dorsal, right ventral face.

1000–1300 m, 27.i.1996, *Schinus patagonicus* (D. Burckhardt); 2 ♂, 1 ♀, Province Cautín, Conguillio National Park, 950 m, 19–21.xii.1990, mixed *Nothofagus* forest, *Schinus patagonicus* (D. Agosti and D. Burckhardt). Dry and slide mounted (MHNG, NHMB).

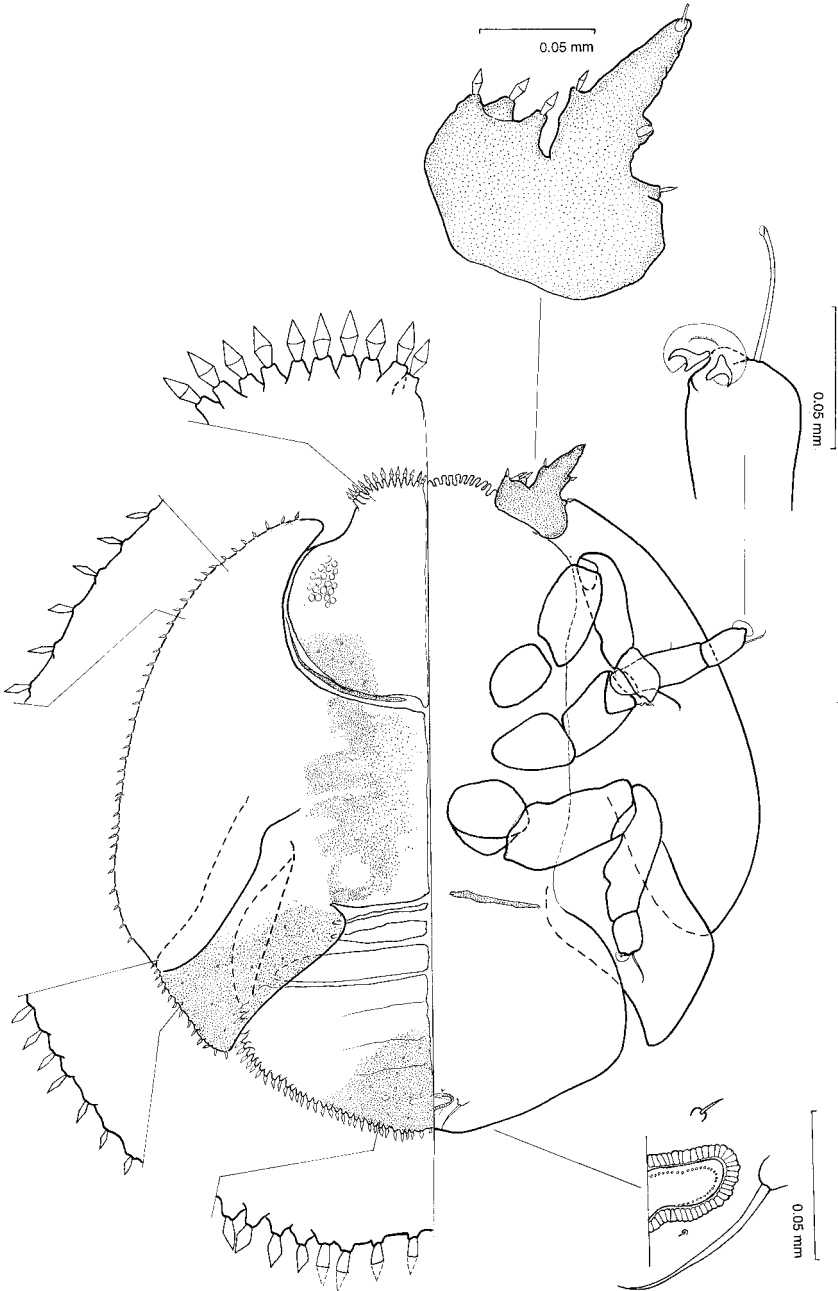

FIG. 22. *Calophya terebinthifolii*, last instar larva; left dorsal, right ventral face.

Material not included in type series. Chile: V Region, galls, same data as holotype; larvae from pit galls on the leaves of *Schinus montanus*, same data but 19 km Portillo to Río Blanco, 1900 m, 23.xii.1995, subalpine scrub; larvae from pit galls on the leaves of *Schinus montanus*, same data but Portillo to Río Blanco, 1800 m, 31.xii.1995, mediterranean scrub; VII Region, larvae from pit galls on the leaves of *Schinus*

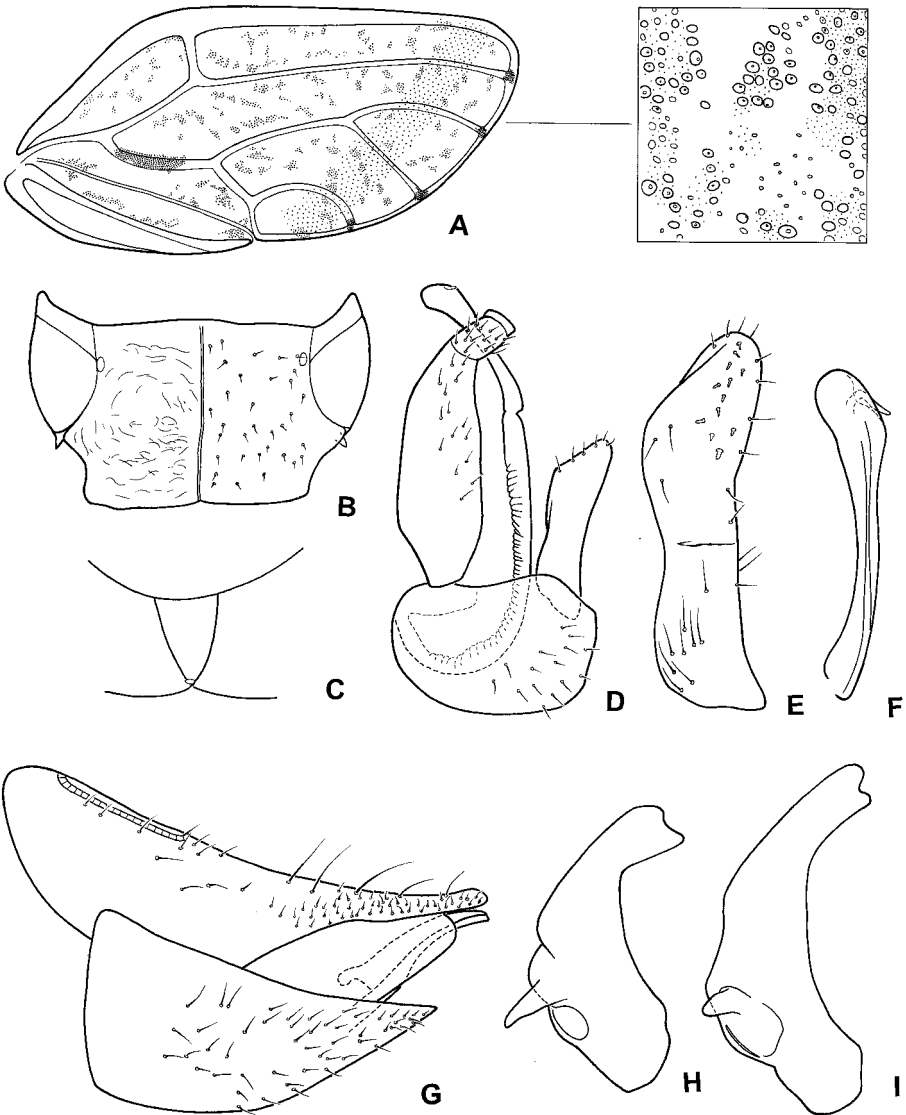

FIG. 23. *Leurolophus* spp.: A–H, *L. oriformae*; I, *L. vittatus*. A, forewing; B, head, dorsal view; C, frons; D, male genitalia, in profile; E, paramere, inner face; F, distal segment of aedeagus; G, female genitalia, in profile; H, I, metacoxa.

patagonicus, Province Talca, Parque Gil de Vilches, Monumento Natural, sector administración to Piedras blancas, 1350–1600 m, 12.i.1996, mixed *Nothofagus* forest (D. Burckhardt); larvae from pit galls on the leaves of *Schinus patagonicus*, same data but sendero El Enladrillado, Valle El Venado, 1350–1700 m, 14.i.1996, mixed *Nothofagus* forest.

***Calophya mammifex* sp. n.**
(figures 7A–F, 16, 60)

Psyllid gall nr. 2, Kieffer and Herbst, 1905: 65; 1906: 234, plate I figs 10, 11
Calophya mammifex nomen nudum, Sáiz and Nuñez, 1997: 39

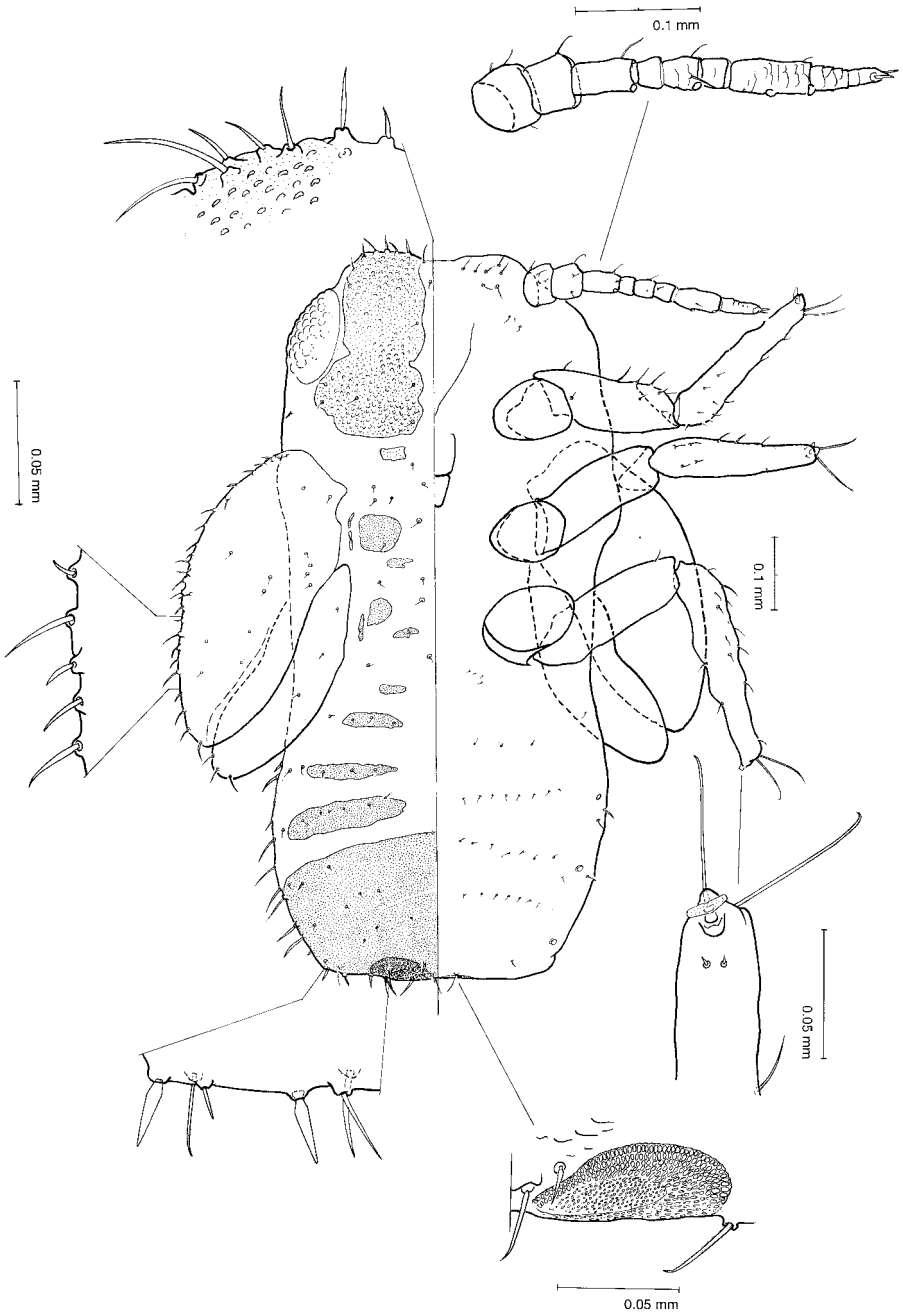

FIG. 24. *Leurolophus oriformae*, last instar larva; left dorsal, right ventral face.

Description. Adult. Coloration. Head and body dark brown. Genal processes whitish. Legs ochreous with darker patches. Forewings light, transparent, veins brown, anterior margin dark brown. Young specimens greenish or yellowish becoming gradually darker with age.

Structure. Anterior portion of vertex covered in setae which are about as long

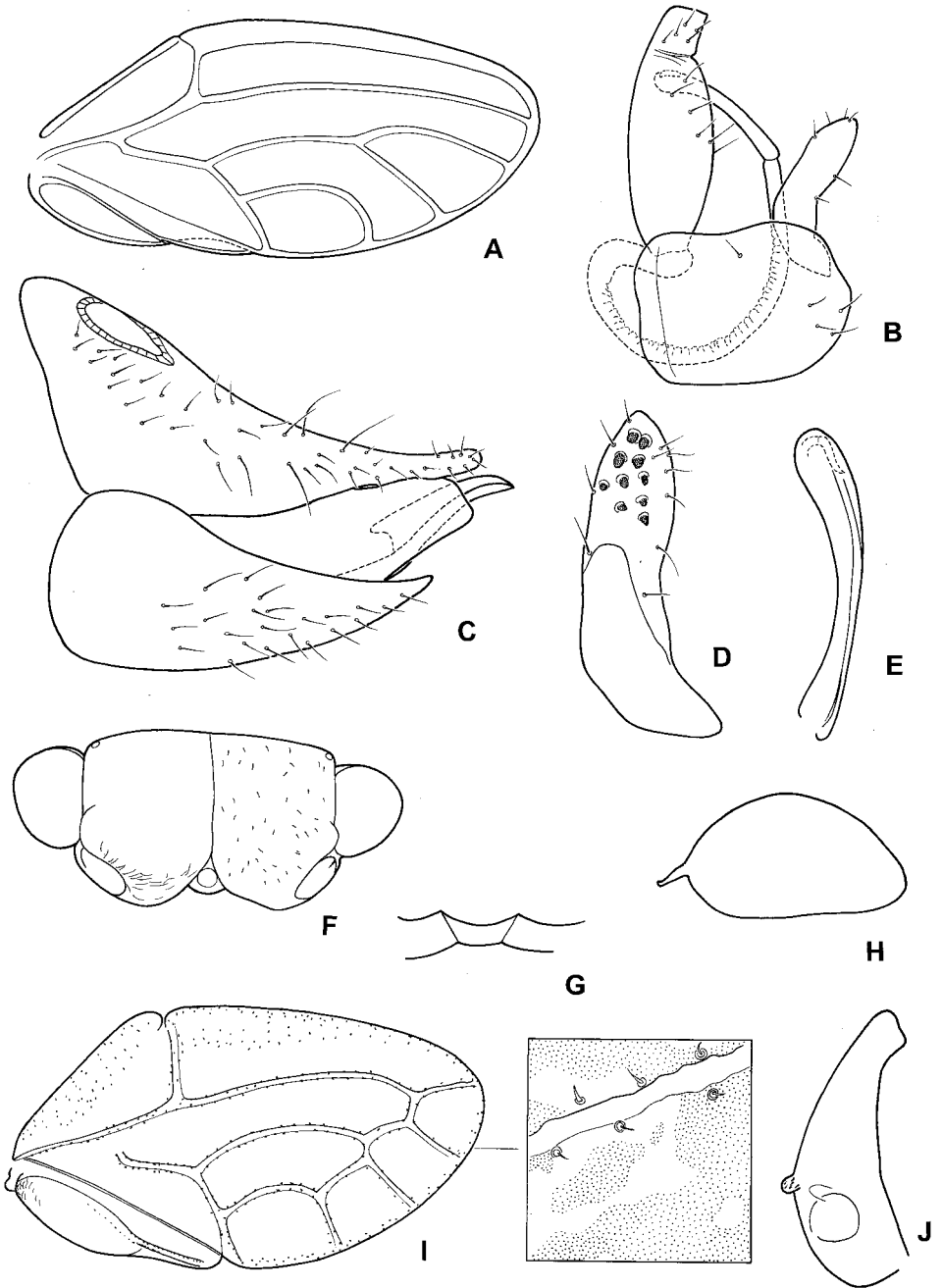

FIG. 25. *Tainarys* spp.: A-E, *T. maculipectus*; F-J, *T. venata*. A, I, forewing; B, male genitalia, in profile; C, female genitalia, in profile; D, paramere, inner face; E, distal segment of aedeagus; F, head, dorsal view; G, frons; H, egg; J, metacoxa.

as distance between them; genal processes long, slender, contiguous in the middle. Forewings (figure 7A) oval, widest in the middle or in apical third, irregularly rounded apically; surface spinules, apart from base, wanting. Genitalia as in

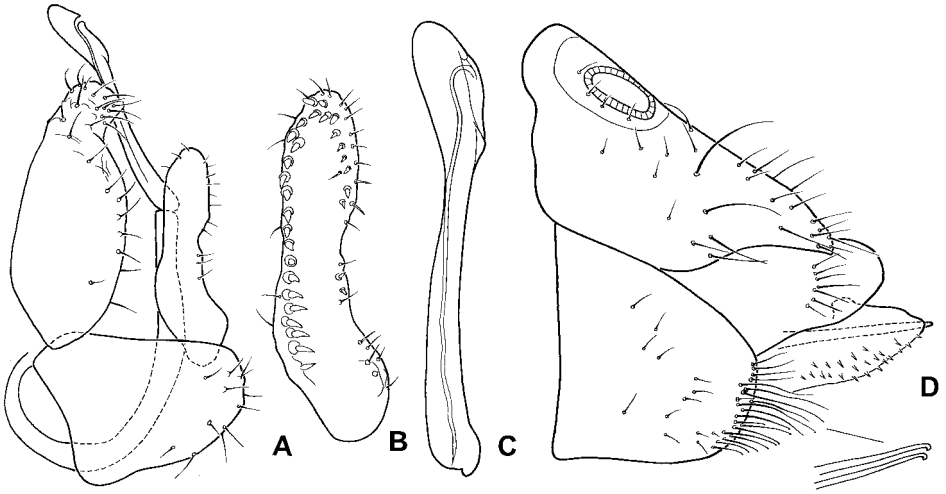

FIG. 26. *Tainarys venata*: A, male genitalia, in profile; B, paramere, inner face; C, distal segment of aedeagus; D, female genitalia, in profile.

figure 7B–F. Male subgenital plate short; proctiger thick; paramere lamellar truncate apically; distal portion of aedeagus long, weakly curved with short globular apical dilatation. Female proctiger with moderately long apical process; subgenital plate relatively short, blunt apically.

Measurements in mm (8 ♂, 12 ♀). HW 0.50–0.67; AL 0.44–0.68; WL 1.57–2.17; MP 0.18–0.23; PL 0.13–0.18; AA 0.14–0.18; FP 0.28–0.38; VL/GL 0.90–1.25; AL/F1 2.50–3.19; AL/HW 0.83–1.20; WL/HW 2.96–3.75; WL/WW 2.08–2.63; a/b 1.00–1.81; c/d 0.55–1.00; TL/HW 0.57–1.00; MP/HW 0.33–0.41; AB/AA 1.00–1.18; FP/HW 0.46–0.66; FP/SL 0.97–1.33; FP/CL 2.21–3.78; FP/FA 2.36–3.20.

Fifth instar larva (figure 16). Yellowish with ochreous to brown dorsal sclerites. Anterior margin of head weakly concavely rounded, not cleft in the middle. Antennae straight, without sectasetae. Legs with claws. Anterior margin of humeral lobes level with posterior eye margin. Abdominal dorsum with median row of horns. Caudal plate ratio 0.56. Circumanal ring oval. Head and wing bud margins without specialized setae; abdominal margin with lanceolate setae.

Host plants, gall and biology. *Schinus latifolius*, *polygamus* and *velutinus*. Inducing nipple galls on the leaves of *Schinus latifolius*, *polygamus* (figure 60) and *velutinus*, and nut galls on the flowers of *S. polygamus*. The leaf gall consists of a hemispherical nipple with hairs at the apex on one leaf face, and of a flattened, disk-shaped swelling on the other face. The gall usually differs in colour from the remainder of the leaf. The chamber is spherical when inhabited by young instars and widens laterally with age. For adult emergence the gall tears open at the orifice producing a serrate margin. The gall shape on the different hosts is similar and the small differences may be due to the physical properties of the leaves. The gall on the fruit is a small nut with hairs around the orifice. Several larvae were parasitized by Hymenoptera. The gall was described and illustrated by Kieffer and Herbst (1905, 1906), and by Nuñez and Sáiz (1994, nr. 48, figure 19, and nr. 51-1, figure 23). According to Sáiz and Nuñez (1997) *C. mammifex* is univoltine. However, Flores (1990) described a bivoltine cycle, erroneously attributed to *Tainarys sordida*, which may concern *C. mammifex*.

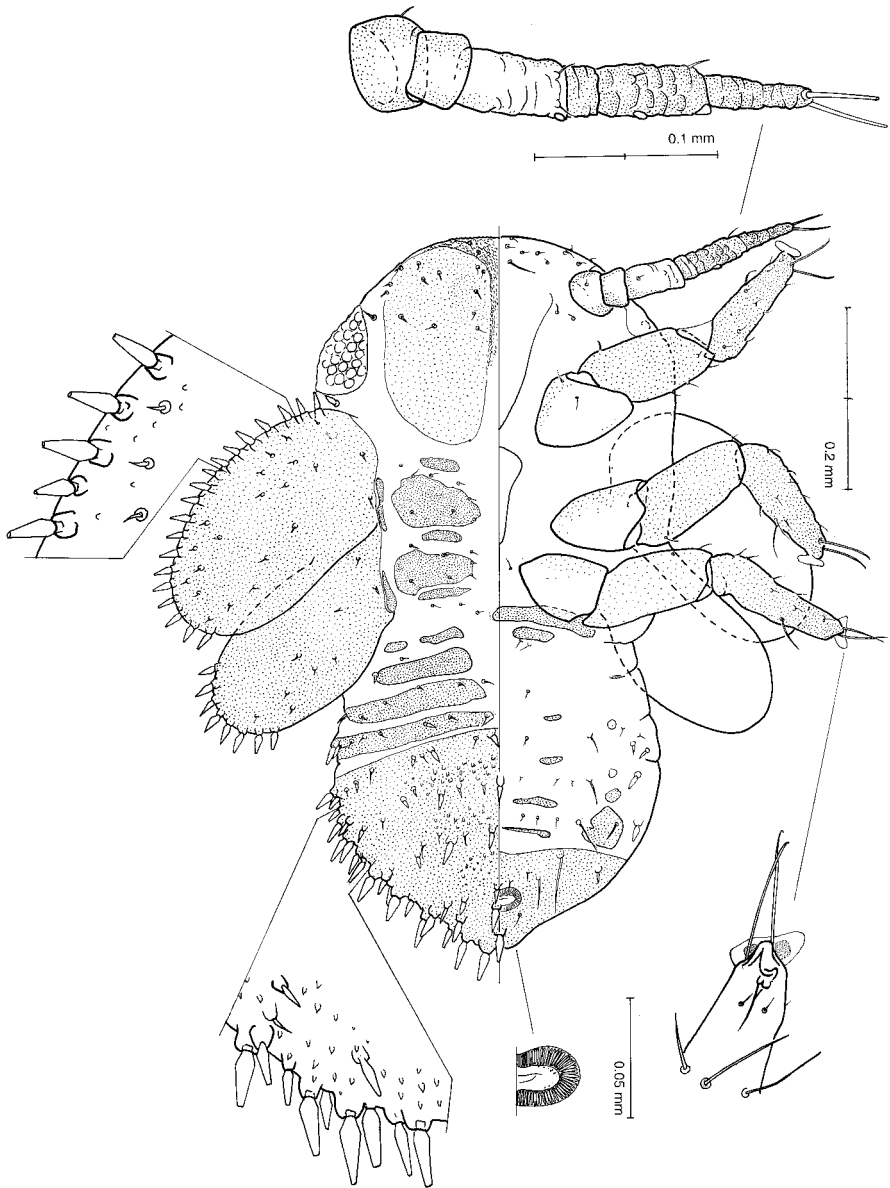

FIG. 27. *Tainarys acuticauda*, last instar larva; left dorsal, right ventral face.

Distribution. Chile (Regions III–VIII, X and Metropolitana). Reported from ‘Quinamarida near Linares between Valparaiso and Santiago’ [sic] (Kieffer and Herbst, 1905, 1906).

Material examined. HOLOTYPE ♂, **Chile:** IV Region, Province Limarí, Fray Jorge National Park, 250 m, 7–9.xii.1990, *Schinus polygamus*, mediterranean scrub (D. Agosti and D. Burckhardt), dry mounted (MHNG).

PARATYPES. **Chile:** III Region, 4 ♂, 6 ♀, 14 km E Vallenar, 22.ii.1985, *Schinus* (D. Hollis); 7 ♂, 1 ♀, Atacama, Copiapo, Nantoco, 19.ix.1952 (P. G. Kuschel); 1 ♂, 1 ♀, Province Huasco, Huasco, 50 m, 28°27'S 71°05'W, 13.xii.1993, *Schinus*

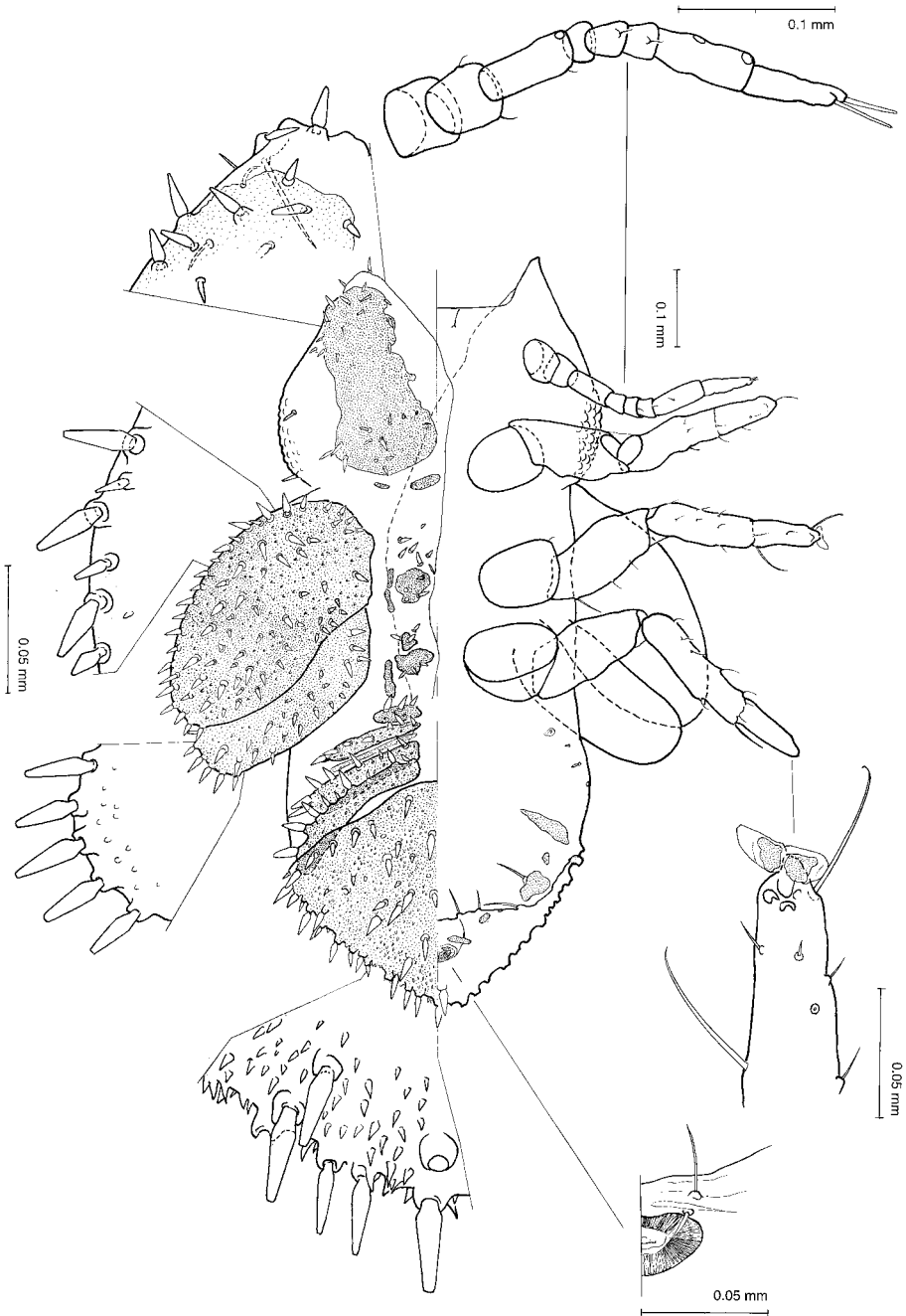

FIG. 28. *Tainarys maculipectus*, last instar larva; left dorsal, right ventral face.

polygamus (D. Burckhardt); IV Region, 1 ♀, El Panque, Vicuña, 1800 m, 17.xi.1987 (L. Peña); 1 ♀, Province Elqui, 15 km SW Viñita Baja, 450 m, 29°50'S 70°50'W, 4.xii.1993, *Schinus polygamus* (D. Burckhardt); 1 ♀, same but 15–25 km S Vicuña, 1300–1700 m, 30°15'S 70°40'W, 14.xii.1993; 11 ♂, 8 ♀, same but 10 km S Vicuña to

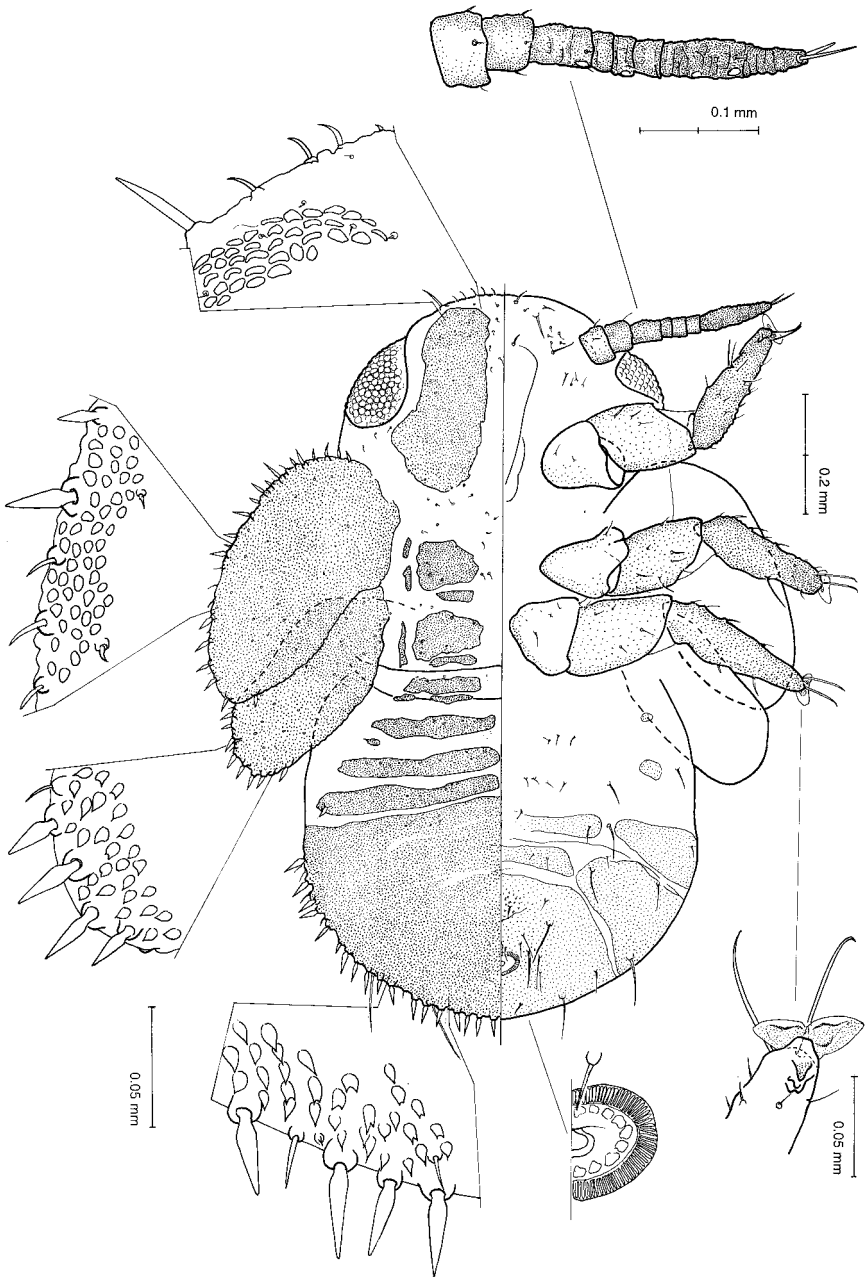

FIG. 29. *Tainarys sordida*, last instar larva; left dorsal, right ventral face.

Hurtado, 900 m, 18.xii.1995; 2 ♂, 1 ♀, 3 larvae, same data but ca 40 km La Serena, 5 km SW Viñita Baja, 450 m, 19.xii.1995; 2 ♂, 2 ♀, same data but 20 km S Vicuña to Hurtado near Puente El Panque, 1600 m, 18.xii.1995; 1 ♂, 4 ♀, same data but ca 45 km ENE La Serena, Viñita Baja to Condoriaco, 800–1000 m, 19.xii.1995; 24 ♂, 14 ♀, 5 larvae, same data but Valle Elqui near Rivadavia, 750 m, 20.xii.1995; 31 ♂, 11 ♀, 2 larvae, same data as holotype, a few specimens also from *Schinus*

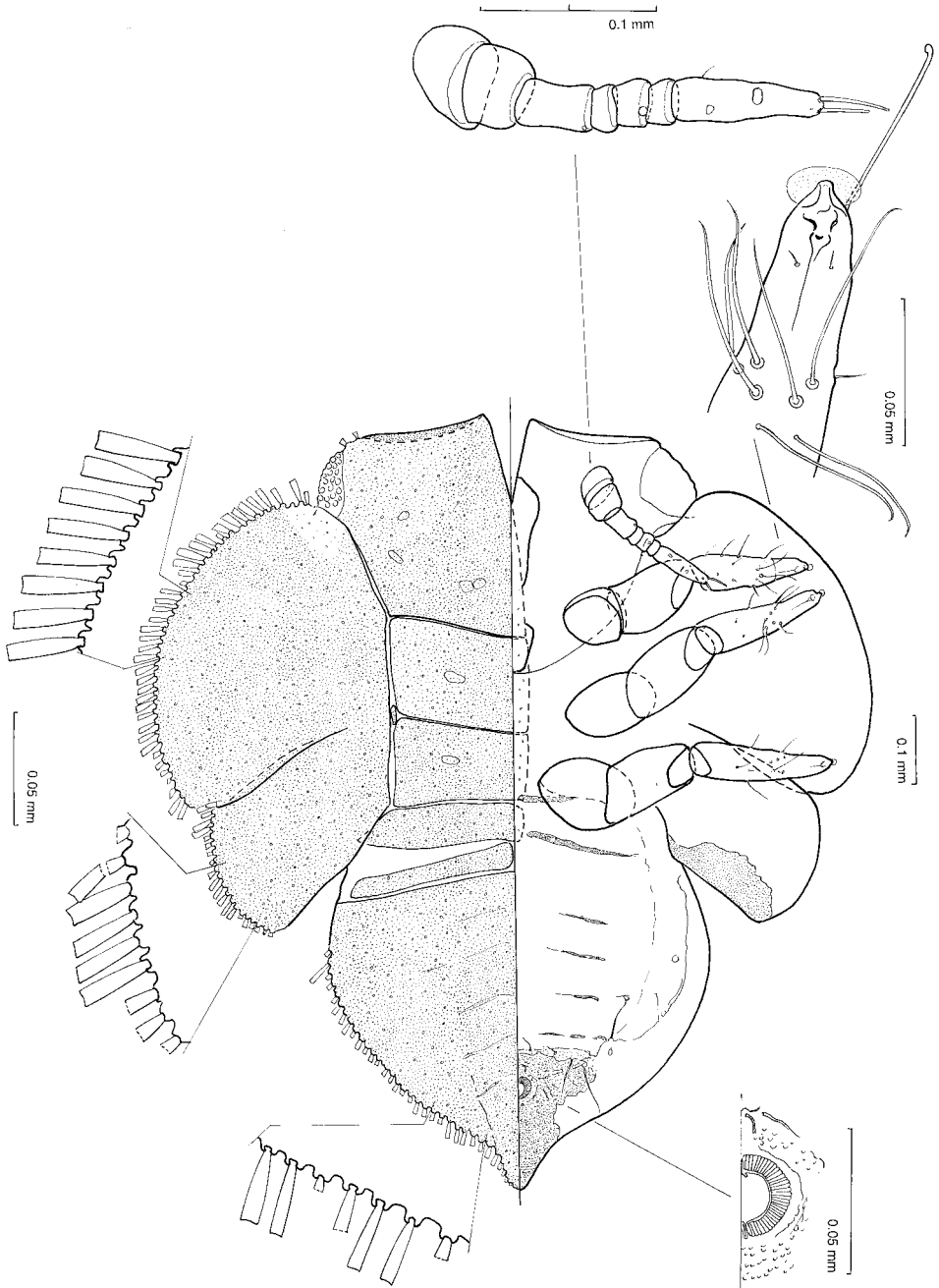

FIG. 30. *Tainarys venata*, last instar larva; left dorsal, right ventral face.

molle; 9 ♂, 13 ♀, same data but 30°40'S 71°40'W, 100 m, 14–16.xii.1992, *Schinus molle*; 44 ♂, 35 ♀, 8 larvae, same data but Quebrada la Vaca, 30°40'S 71°40'W, 100–200 m, 15–17.xii.1992, *Schinus polygamus* a few specimens also on *Schinus molle*; 6 ♂, 6 ♀, same data but foot of hill, 18.ii.1985, *Schinus polygamus* (D. Hollis); 5 ♂, 3 ♀, Choapa, 272 km Panamericana Norte, 23.x.1985, *Schinus latifolius*, *Adesmia*

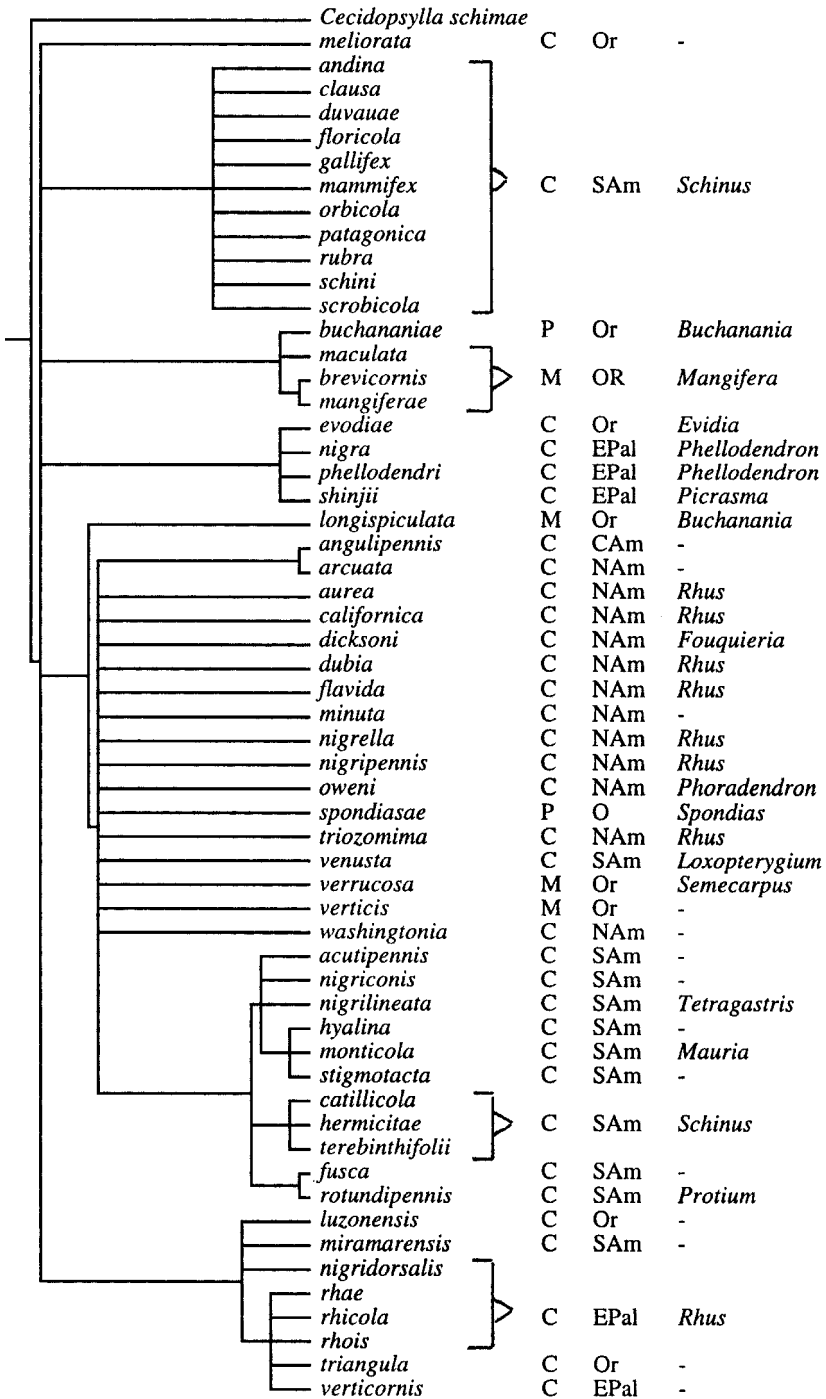
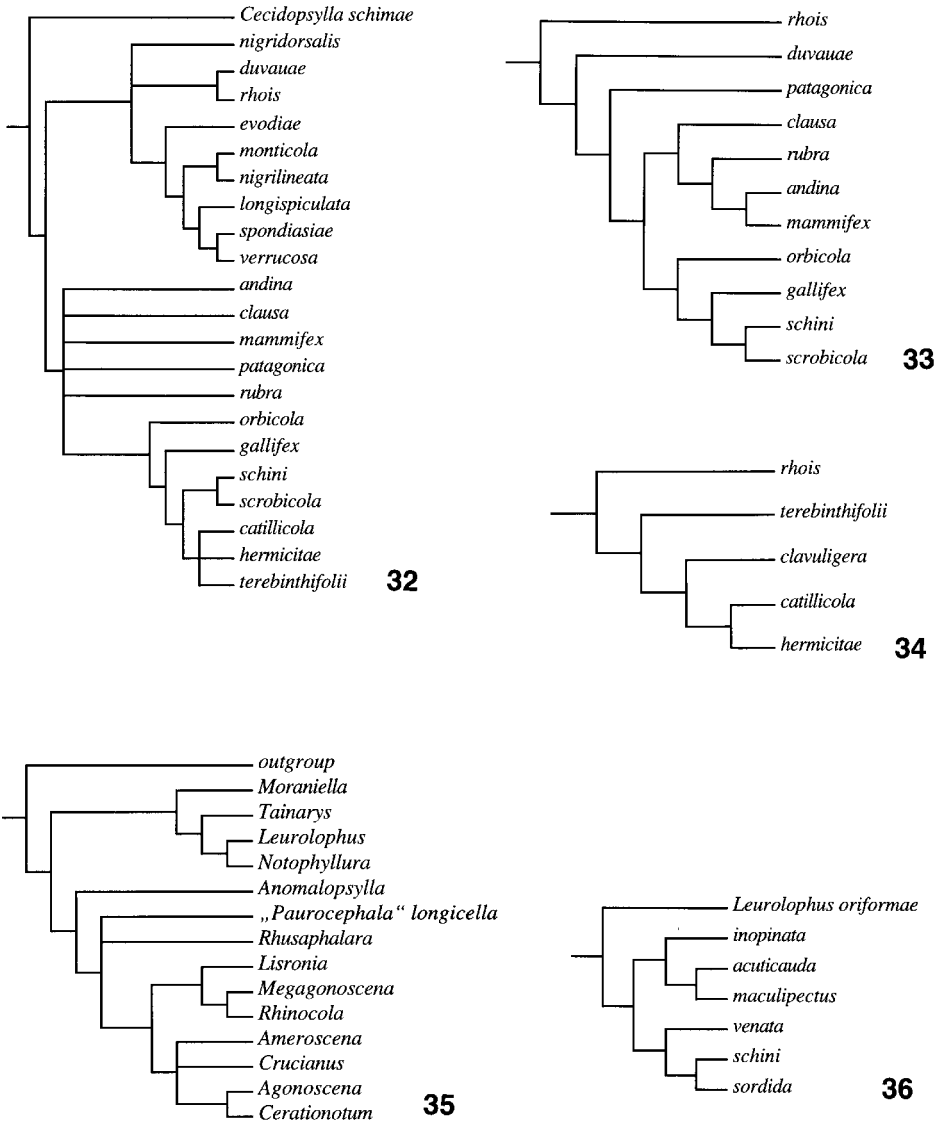

FIG. 31. Cladogram of all *Calophya* species (except for *C. clavuligera* and *C. pallidula*), with previous combinations (C = *Calophya*, P = *Pelmatobranchia*, M = *Microceropsylla*), provenance (EPal = East Palaearctic, Or = Oriental, NAM = North American, SAM = South American) and host genus (adult characters, cf. tables 4, 5).



FIGS 32–36. Cladograms: (32) selected *Calophya* spp. (adult and larval characters, cf. tables 6, 7); (33) *Calophya rubra* group (except for *C. floricola*) (cf. tables 8, 9); (34) *Calophya hermiticae* group (cf. tables 10, 11); (35) Rhinocolinae (cf. tables 12, 13); (36) *Tainarys* (cf. tables 14, 15).

microphylla (M. Elgueta); 3 ♂, same data but 19.xi.1985, *Schinus latifolius*; 1 ♀, same data but 17.xii.1985, *Baccharis concava*; 1 ♀, Choapa, Quereo, S Los Vilos, 27.x.1991 (M. Elgueta); 12 ♂, 16 ♀, same data but 3.x.1993 (L. E. Peña and A. Ugarte); V Region, 3 ♂, 1 ♀, Province Valparaiso, Fundo El Pequén, Valle Marga Marga, 33°06'S 71°23'W, 200 m, 21.xi.1992, *Schinus latifolius* (D. Burckhardt); 23 ♂, 9 ♀, same data but Estero Catapilco near Maitencillo, 32°40'S 71°27'W, 50 m, 22.xi.1992; 2 ♂, Province Petorca, Cuesta El Melón, 400 m, 22.xii.1995, *Schinus velutinus* (D. Burckhardt); 1 ♂, 13 larvae, Province Quillota, Quillota, El Boco, 5.v.1993,

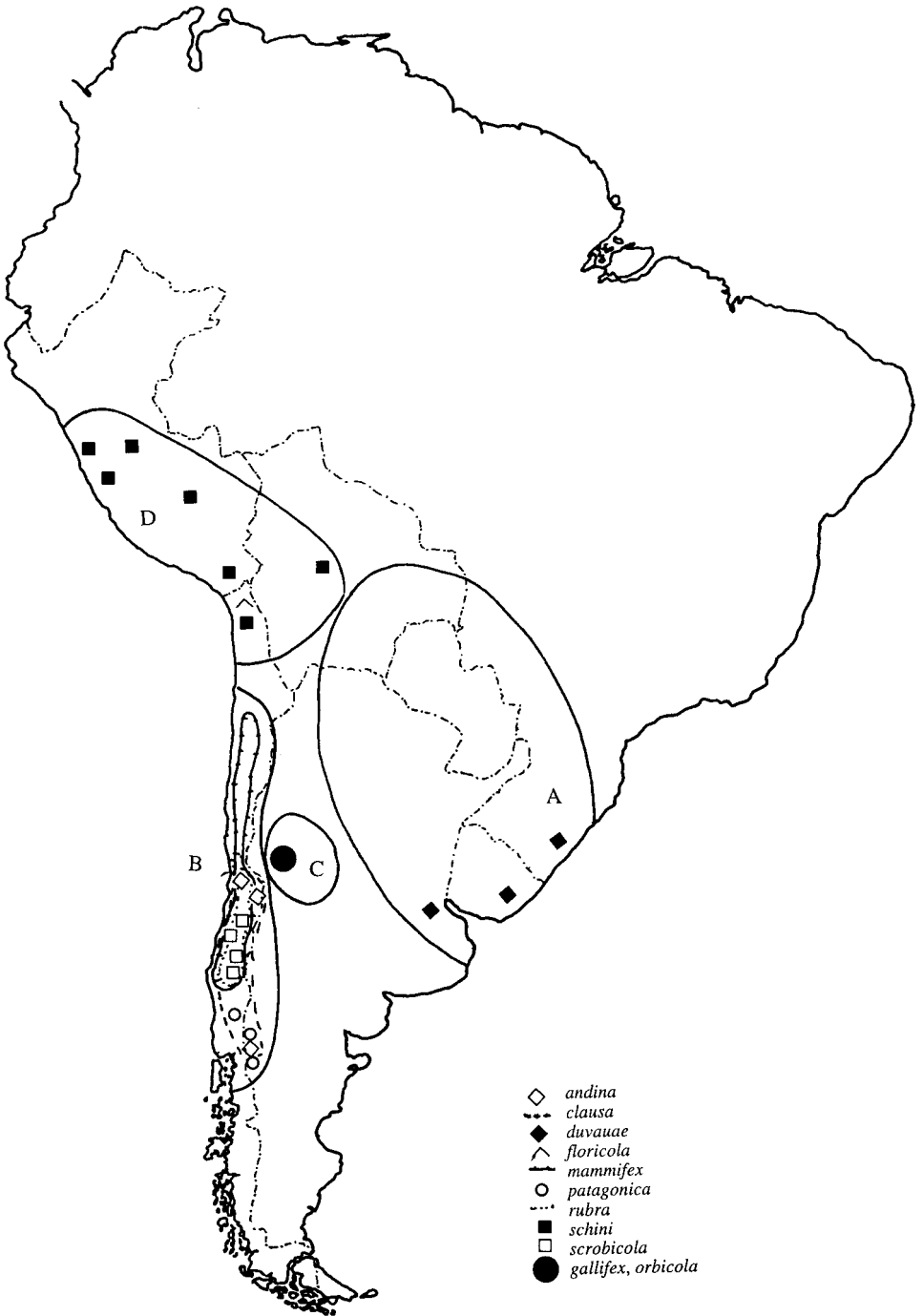
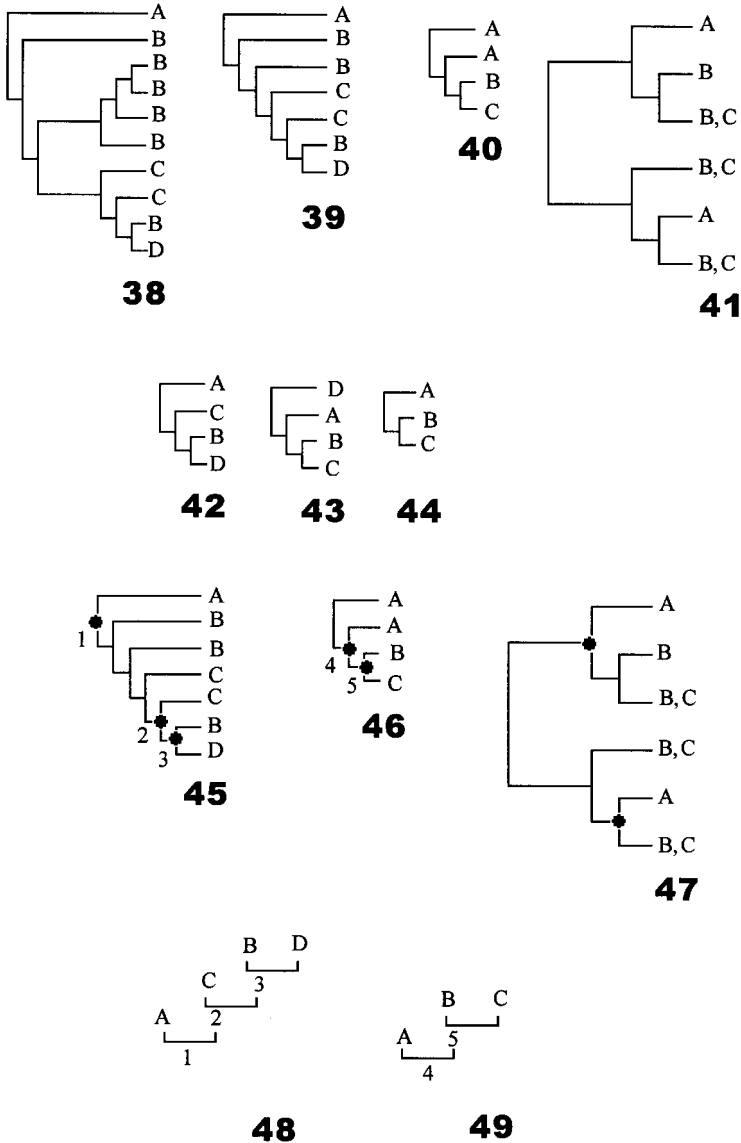

FIG. 37. Distribution of the species of the *Calophya rubra* group.

Schinus velutinus (D. Burckhardt); 1 ♂, 2 ♀, same data but La Campana National Park, 800 m, 32°59'S 71°07'W, 15–21.xi.1992, *Schinus latifolius*; 3 ♂, 3 ♀, same data but 1300 m, 11.i.1985, *Schinus* sp. (D. Hollis); ca 10 first to fifth instar larvae (mostly



FIGS 38–49. (38) Taxon area cladogram (TAC) of the *C. rubra* group; (39) simplified TAC of figure (38, 40) TAC of the *C. hermicitae* group; (41) TAC of *Tainarys*; (42) reduced area cladogram (RAC) of the *C. rubra* group; (43) RAC of the *C. hermicitae* group; (44) RAC of *Tainarys*; (45) TAC of the *C. rubra* group with three traceable vicariance events (TVE); (46) TAC of the *C. hermicitae* group with two TVE; (47) TAC of *Tainarys* without TVE; (48) diagram of vicariant events derived from cladogram of the *C. rubra* group (figure 45); (49) diagram of vicariant events derived from cladogram of the *C. hermicitae* group (figure 46).

smaller instars), same data but La Campana National Park, Sector Ocoa, 400–500 m, 3.vii.1993, from leaf galls of *Schinus polygamus* (F. Sáiz); ca 30 first to fifth instar larvae (mostly larger instars), same data but 19.vii.1993; 40–50 first to fifth instar larvae (mostly small instars), same data but 9.ix.1993; 53 first to fifth instar

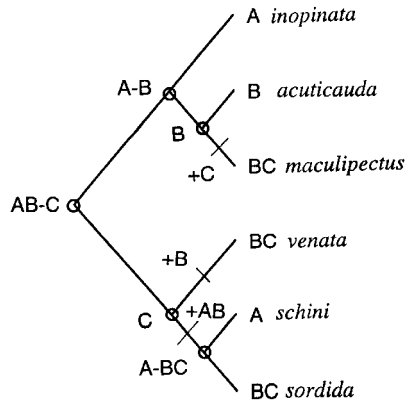
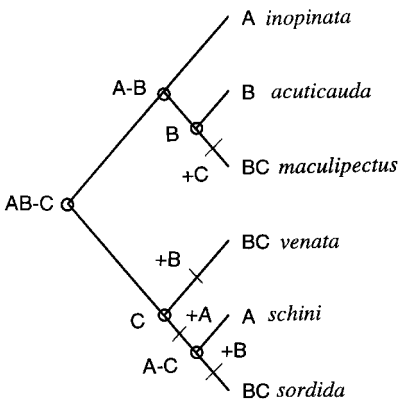
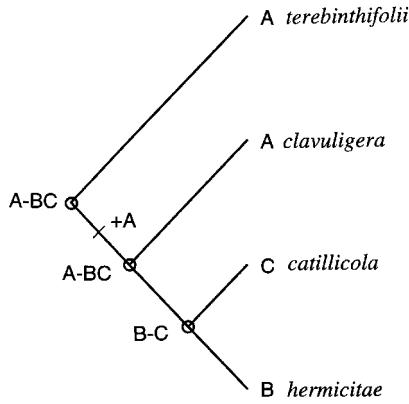

larvae, same data but 24.ix.1993; *ca* 15 first to fifth instar larvae (mostly large instars), same data but 15.xi.1993; *ca* 60 first to fifth instar larvae (mostly small instars), same data but 25.i.1994; *ca* 60 first or second instar larvae, same data but 7.iv.1994; *ca* 30 first to fifth instar larvae (mostly small instars), same data but 30.v.1994; *ca* 20 first to fifth instar larvae, same data but 12.vii.1994; *ca* 30 first to fifth instar larvae, same data but 29.viii.1994; *ca* 40 first to fifth instar larvae, same data but 12.ix.1994; *ca* 20 first to fifth instar larvae, same data but 10.x.1994; *ca* 50 first to fifth instar larvae, same data but 12.xii.1994; *ca* 30 first or second instar larvae, same data but 9.i.1995; 1 ♂, 2 ♀, 1 larva, same data but xi.1995; 1 ♂, 3 ♀, 1 adult without abdomen, same data but without date; 11 second, third and fifth instar larvae, same data but 9.viii.1993, from leaf galls on *Schinus latifolius*; 7 first and 1 fifth instar larvae, same data but 25.x.1993; 48 first/second, 1 third and 3 fifth instar larvae, same data but 6.xii.1993; 42 first/second and 3 fifth instar larvae, same data but 29.xii.1993; *ca* 40 first/second, 1 third, 1 fourth and 1 fifth instar larvae, same data but 25.i.1994; 46 first/second, 3 third, and 1 fifth instar larvae, same data but 7.iv.1994; *ca* 30 first to third and 1 fifth instar larvae, same data but 2.v.1994; *ca* 5 fourth and *ca* 25 fifth instar larvae, same data but 12.vii.1994; 1 third and 10 fifth instar larvae, same data but 16.viii.1994; *ca* 30 mostly fifth instar larvae, same data but 26.ix.1994; *ca* 30 first/second, 1 fourth and 7 fifth instar larvae, same data but 31.x.1994; *ca* 10 first/second and 2 fifth instar larvae, same data but 12.xii.1994;

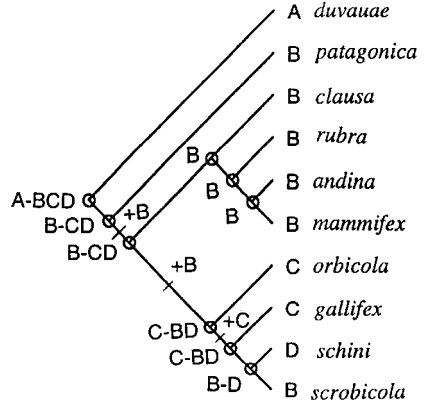
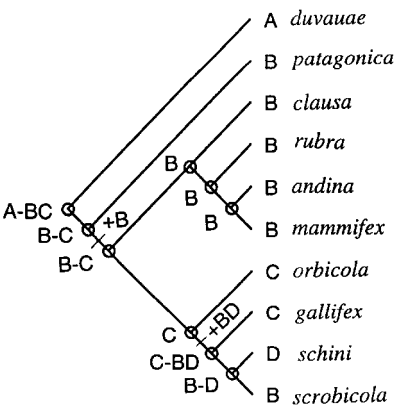
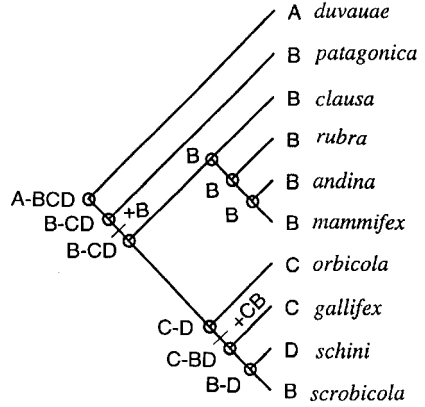
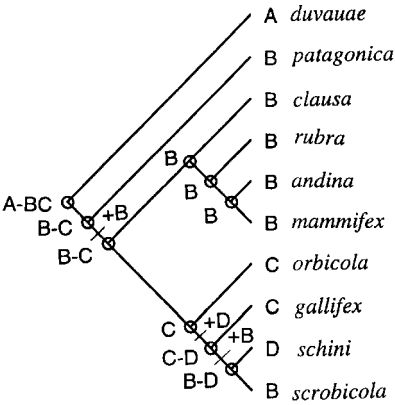
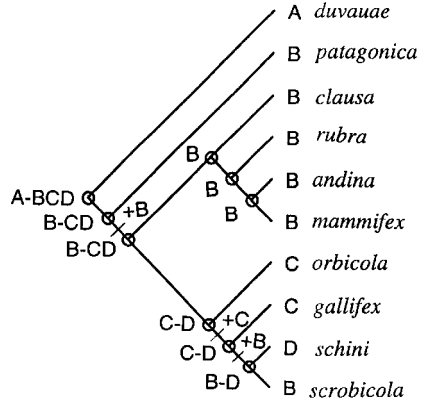
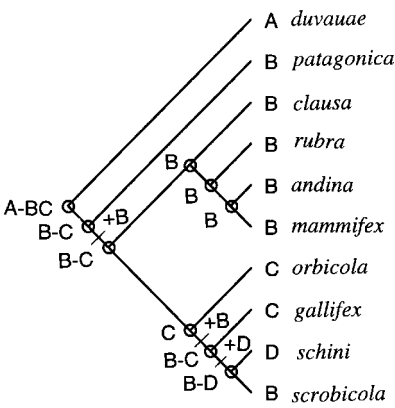

Figs 50–52. Biogeographic reconstructions with DIVA: (50) *C. hermitiae* group; (51) *Tainarys*; (52) *C. rubra* group.

ca 80 first/second and 1 fifth instar larvae, same data but 19.i.1995; 6 ♂, 4 ♀, 2 second instar larvae, same data but without date; 20 fourth and fifth instar larvae, same data but 12.ix.1994, on flowers of *Schinus latifolius*; 17 ♂, 14 ♀, 1 exuvia, same

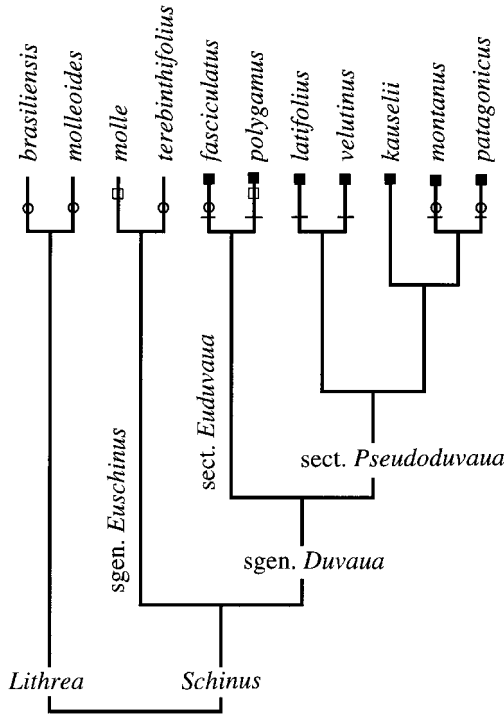
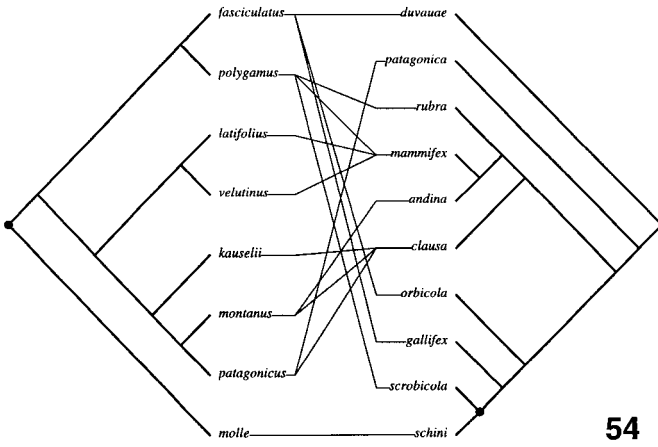
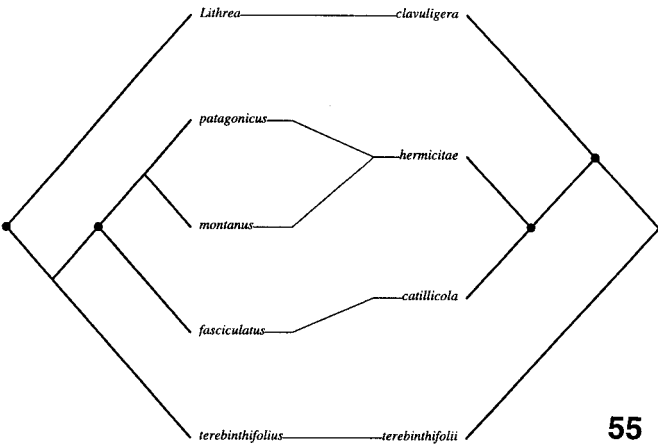

FIG. 53. Phylogenetic relationships of *Lithrea* and *Schinus* with deformations produced by Psylloidea:—irregularly deformed leaves by *Tainarys* spp.; open circle pit galls by members of the *C. hermiticae* group; open square pit galls by members of the *C. rubra* group; solid square closed galls by members of the *C. rubra* group.

data but 10.x.1994; 11 ♂, 15 ♀, 1 larval skin, same data but Quillota, La Palma, 300 m, 25.xii.1995, *Schinus velutinus* (D. Burckhardt); 6 ♂, 5 ♀, 1 larval skin, same data but *Schinus latifolius*; 1 ♀, Province San Felipe, El Tártaro, 25 km N San Felipe, 32°37'S 70°42'W, 1000 m, 26.xii.1993, *Schinus polygamus* (D. Burckhardt); 4 ♂, same data but El Tártaro, 20 km N San Felipe, Putaendo Valley, 1100 m, 24.xii.1995; 11 ♂, 13 ♀, same data but El Asiento, 10 km NW San Felipe, 900 m, 13–20.i.1997; 1 ♂, 3 ♀, same data but Termas de Jahuel, 1000 m, 21.i.1997, *Acacia caven* steppe with planted exotic trees; 5 ♂, 1 ♀, Province Los Andes, 25 km W Portillo, 32°50'S 70°08'W, 1900–2100 m, 1.xii.1993, *Schinus polygamus* (D. Burckhardt); 10 ♂, 3 ♀, same data but 28 km Portillo to Río Blanco, Aconcagua Valley, 1500 m, 23.xii.1995; 1 ♂, 1 ♀, same data but near Portillo Ski Centre, Guardia Vieja, 21.x.1995 (R. Muñoz G.); Province San Antonio, 3 ♀, Las Cruces, near San Antonio, 17.v.1961, *Schinus latifolius* (N. L. H. Krauss); Region Metropolitana: 2 ♂, 1 ♀, Province Tiltill, Cuesta La Dormida, 7–10 km km W Tiltill, 33°04'S 71°02'W, 950–1200 m, 28.xii.1993, *Schinus polygamus* (D. Burckhardt); 34 ♂ and ♀, 29–41 km Santiago to La Disputada Road, 9.i.1985, *Schinus polygamus* (D. Hollis); VI Region, 10 ♂, 20 ♀, 1 larval skin, Province Colchagua, Bellavista, Río Claro, 900 m, 11.i.1996, *Schinus polygamus* (D. Burckhardt). Dry and slide mounted (BMNH, HNHM, MHNG, MHNS, MNHN, NHMB, UCVA, USNM).



54



55

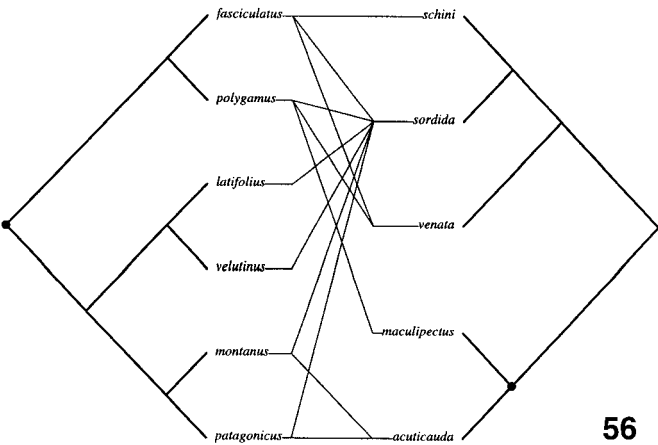

56

FIGS 54–56. Associations of *Schinus/Lithrea* (left) and psylloids (right): (54) *Calophya rubra* group; (55) *Calophya hermicitae* group; (56) *Tainarys*.

Material not included in type series. **Chile:** IV Region, galls on the leaves, Rivadavia, 800 m, xi.1923, *Schinus polygamus* (E. Werdermann); galls on leaves and flowers of *Schinus polygamus*, same data as holotype; galls on leaves and flowers on *Schinus polygamus*, same data but Quebrada la Vaca, 30°40'S 71°40'W, 100–200 m, 15–17.xii.1992; nipple galls on leaves of *Schinus polygamus*, Province Elqui, 20 km S Vicuña towards Hurtado near puente El Pangue, 1600 m, 18.xii.1995, semi-desert and quebrada with water (D. Burckhardt); nipple galls on leaves, same data but 10 km S Vicuña; nipple galls on leaves of *Schinus polygamus*, same data but 40 km E La Serena, 5 km SW Viñita Baja, 450 m, 19.xii.1995, quebrada; nipple galls on leaves of *Schinus polygamus*, same data but Valle Elqui near Rivadavia, 750 m, 20.xii.1995, semi-desert with *Baccharis* shrubs and scattered trees in lowest part; V Region, nipple galls on the leaves, Province Petorca, Cuesta El Melón, 400 m, 22.xii.1995, *Schinus velutinus* (D. Burckhardt); galls on leaves of *Schinus polygamus*, Province San Felipe, Los Patos, 35 km N San Felipe, 17.v.1993, 17.v.1993 (D. Burckhardt); nipple galls on leaves of *Schinus polygamus*, same data but El Asiento, 10 km NW San Felipe, 900 m, 13–20.i.1997, mediterranean scrub; nipple galls on leaves of *Schinus polygamus*, same data but Termas de Jahuel, 1000 m, 21.i.1997, *Acacia caven* steppe with planted exotic trees; larvae from nipple galls on the leaves, same data but Putaendo, 8 km N San Felipe, 700 m, 12–13.i.1997; nipple galls on leaves of *Schinus polygamus*, same data but Province Los Andes, 28 km Portillo to Río Blanco, Aconcagua Valley, 1500 m, 23.xii.1995, mediterranean scrub; nipple galls on the leaves, Río Aconcagua, near Los Andes, 800 m, 18.i.1904, *Schinus polygamus*; larvae from nipple galls on leaves of *Schinus latifolius* and *velutinus*, Province Quillota, Quillota, La Palma, 300 m, 25.xii.1995, *Acacia caven* steppe and gullies with mediterranean scrub (D. Burckhardt); larvae from nipple galls on the leaves, same data but 15.i.1996, *Schinus velutinus*; Region Metropolitana, nipple galls on the leaves, Santiago, slopes of Mount San Christobal, 25.iv.1904, *Schinus polygamus*; VI Region, nipple galls on leaves of *Schinus polygamus*, Province Colchagua, La Ruffina, Río Tinguiririca, 650 m, 11.i.1996, mediterranean sclerophyll scrub (D. Burckhardt); VII Region, nipple galls on leaves, Province Curicó, road to Argentina, beyond Los Queñes, along Arroyo La Jaula in Andean foothills, 1218 m, 13.ii.1936, *Schinus polygamus* (Y. Mexia); nipple galls on the leaves, Province Linares, 10 km W Parral, 400 m, 12.ii.1996, *Schinus polygamus*, open degraded scrub (D. Burckhardt); nipple galls on leaves of *Schinus polygamus*, Province Cauquenes, 10 km W Cauquenes, 400 m, 12.ii.1996, open degraded scrub (D. Burckhardt); VIII Region, nipple galls on leaves of *Schinus polygamus*, Province Biobío, Parque Nacional Laguna del Laja, sector Lagunillas, 1100 m, 21.i.1996, open *Austrocedrus* forest and sclerophyll scrub (D. Burckhardt); X Region, Province Valdivia, San José de la Mariquina, 50 m, iii.1926 (A. Hollermayer). Dry mounted and preserved in alcohol (BMNH, MHNG, NHMB).

Comments. There are very minor differences in the shape, size and colour of the nipple galls on the leaves of *Schinus latifolius*, *polygamus* and *velutinus* respectively (figure 60) (Burckhardt, pers. obs.). We could not find morphological differences in the adults and fifth instar larvae from the three hosts and conclude that they are conspecific. Other, perhaps biochemical, methods should be used to test our conclusion.

***Calophya orbicola* sp. n.**

(figures 7G–K, 17)

Trioza sp.? Kieffer and Jörgensen, 1910: 387; Jörgensen, 1917: 6

Description. Adult. Coloration. Head and body dark brown to black. Tips of genal processes and antennal segments 1–8 greyish brown. Tibiae and basitarsi yellowish. Intersegmental membranes of abdomen light reddish brown. Forewings ochreous, veins brown. Young specimens yellowish orange, becoming gradually darker.

Structure. Anterior portion of vertex covered in setae which are in average shorter than distance between them; genal processes long, slender, contiguous in the middle. Forewings (figure 7H) oval, widest in the middle, irregularly rounded apically; surface spinules, apart from base, wanting. Genitalia as in figure 7G, I–K. Male subgenital plate short; proctiger massive; paramere lamellar obliquely truncate apically; distal portion of aedeagus slender, hardly curved with short flattened apical dilatation. Female proctiger with long apical process; subgenital plate long, pointed apically.

Measurements in mm (2 ♂, 2 ♀). HW 0.61–0.63; AL 0.65–0.77; WL 2.24–2.26; MP 0.24–0.26; PL 0.16–0.18; AA 0.20–0.22; FP 0.44–0.48; VL/GL 0.95–1.54; AL/F1 2.18–2.48; AL/HW 1.07–1.26; WL/HW 3.56–3.81; WL/WW 2.25–2.43; a/b 1.38–1.55; c/d 0.74–0.98; TL/HW 0.83–0.90; MP/HW 0.38–0.41; AB/AA 0.95; FP/HW 0.72–0.77; FP/SL 1.29–1.37; FP/CL 3.67–4.00; FP/FA 2.82–2.93.

Fifth instar larva (figure 17). Anterior margin of head weakly concavely rounded, not cleft in the middle. Antennae strongly curved downwards, without sectasetae. Legs with claws. Anterior margin of humeral lobes level with the middle of eye margin. Abdominal dorsum without median row of horns. Caudal plate ratio 0.49. Circumanal ring absent. Head and wing bud margins with clavate setae; abdominal margin with very slender and elongate lanceolate setae.

Host plant, gall and biology. *Schinus fasciculatus*. Inducing disk or spherical galls on the leaves. The gall was described by Kieffer and Jörgensen (1910) and Jörgensen (1917).

Distribution. Argentina (Mendoza). Reported from the Cordilleras from Mendoza (Kieffer and Jörgensen, 1910; Jörgensen, 1917).

Material examined. HOLOTYPE ♂, **Argentina**: Province Mendoza, above Villa Vicencia, 50 km NW Mendoza, 1800–2200 m, 18.i.1997, *Schinus fasciculatus* (D. Burckhardt), dry mounted (MHNG).

PARATYPES. **Argentina**: 20 ♂, 24 ♀, 2 larvae, same data as holotype; 1 ♀, same data but 47 km Mendoza to Villa Vicencia, 1400 m, 18.i.1997; 2 ♀, same data but Mendoza Valley, Uspallata to Potrerillos, 1700 m, 30–31.xii.1995; 1 ♀, same data but Punta de Vacas to Uspallata, 1900 m, 16–19.i.1997; 2 ♀, same data but Potrerillos, 1300 m, 17.i.1997; 2 ♂, 4 ♀, same data but Villa Hodel, 7 km Cacheuta to Mendoza, 1100 m, 17.i.1997; 1 ♀, Mendoza, Zoological Garden, vii.1997 (S. Roig); dry and slide mounted (BMNH, MHNG, NHMB, USNM).

Material not included in type series. **Argentina**: disk or spherical galls on leaves of *Schinus fasciculatus*, Province Mendoza, 47 km Mendoza to Villa Vicencia, 1400 m, 18.i.1997 (D. Burckhardt); disk galls on leaves of *Schinus fasciculatus*, same data

FIGS 57–62. Galls of *Calophya* spp. on *Schinus* spp.: (57) *C. clausa* on *S. patagonicus*, young galls; (58) *C. clausa* on *S. patagonicus*, arrow: gall after emergence of insect; (59) *C. hermiticae* on *S. montanus*, black arrow, underside, white arrow: empty gall upper side; (60) *C. mammifex* on *S. polygamus*, arrows: young galls; (61) *C. rubra* on *S. polygamus*; (62) *C. schini* on *S. molle*, left arrow: underside of gall, right arrows pit galls occupied with last instar larvae.

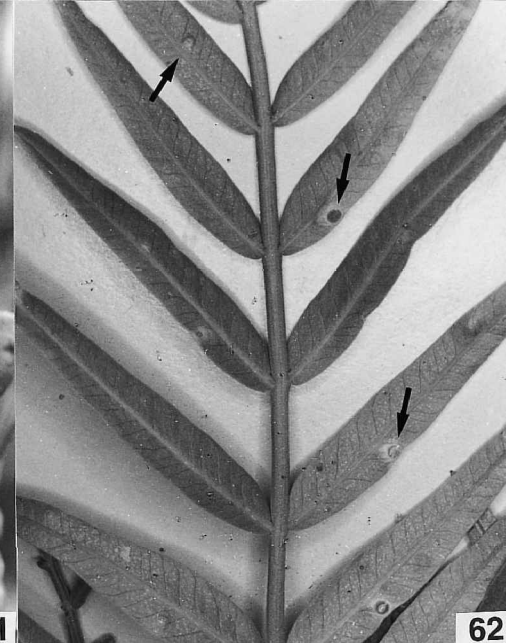
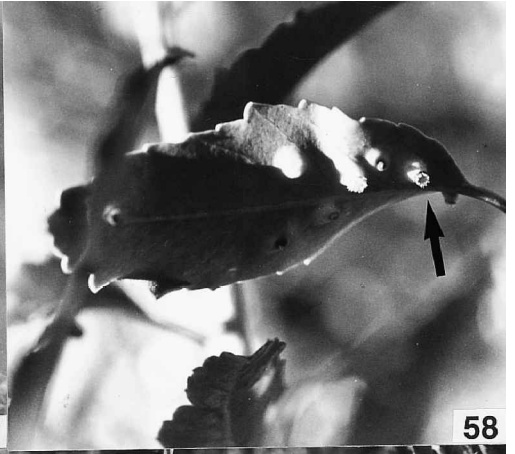

Downloaded By: [Romanian Ministry Consortium] At: 10:24 20 May 2010

but above Villa Vicencia, 50 km NW Mendoza, 1800–2200 m, low scrub; disk or spherical galls on leaves of *Schinus fasciculatus*, same data but Mendoza Valley, Uspallata to Potrerillos, 1700 m, 30–31.xii.1995; several first to third instar larvae, same data as holotype; preserved in alcohol (MHNG).

***Calophya patagonica* sp. n.**

(figures 8A–F, 18)

Description. Adult. Coloration. Head and body dark brown to black. Tips of genal processes brown. Legs yellow, apicotarsi greyish brown. Genitalia variegated ochreous and brown. Forewings yellowish with brown veins. Young specimens with more reddish coloration darkening gradually.

Structure. Anterior portion of vertex covered in very short and inconspicuous setae; genal processes moderately long, slender, contiguous in the middle. Forewings (figure 8A) narrowly oval, widest in the middle, angularly rounded apically; surface spinules present in all cells, forming smaller or larger patches along outer margin. Genitalia as in figure 8B–F. Male subgenital plate short; proctiger thick; paramere lamellar, long, truncate apically; distal portion of aedeagus straight, long, with small globular apical dilatation. Female proctiger and subgenital plate with long, pointed apical processes.

Measurements in mm (3 ♂, 3 ♀). HW 0.62–0.67; AL 0.56–0.64; WL 1.98–2.39; MP 0.22–0.24; PL 0.18–0.21; AA 0.25–0.27; FP 0.63–0.64; VL/GL 1.29–1.44; AL/F1 2.67–3.11; AL/HW 0.84–0.97; WL/HW 3.19–3.62; WL/WW 2.25–2.38; a/b 1.39–1.56; c/d 0.91–1.10; TL/HW 0.66–0.72; MP/HW 0.35–0.37; AB/AA 0.72–1.00; FP/HW 0.94–0.98; FP/SL 1.07–1.14; FP/CL 4.50–5.82; FP/FA 2.21–2.33.

Fifth instar larva (figure 18). Dark brown. Anterior margin of head weakly concavely rounded, not cleft in the middle. Antennae straight, without sectasetae. Legs with claws. Anterior margin of humeral lobes level with posterior eye margin. Abdominal dorsum without median row of horns. Caudal plate ratio 0.59. Circumanal ring oval. Head and wing bud margins with short thick setae; abdominal margin with lanceolate setae.

Host plant, gall and biology. *Schinus patagonicus*. Inducing flat disk-shaped galls on the leaves. The galls are usually situated at the leaf base or along the mid-rib. The orifice is devoid of hairs.

Distribution. Argentina (Chubut, Río Negro), Chile (IX Region).

Material examined. HOLOTYPE ♂, **Chile:** IX Region, Province Cautín, Conguillío National Park, 1150 m, Playa Linda, *Nothofagus antarctica* forest, 19–20.xii.1990, *Schinus patagonicus* (D. Agosti and D. Burckhardt), dry mounted (MHNG).

PARATYPES. **Argentina:** 1 ♂, 1 ♀, Chubut, Derrumbe, 18.xi.1961 (Topal); 1 ♀, Río Negro, Correntoso, xi.1926 (R. and E. Shannon). **Chile:** 7 ♂, 3 ♀, same data as holotype; 1 ♂, 5 larvae from glabrous disk-shaped galls, same data but 1100 m, 30.i.1996 (D. Burckhardt). Dry and slide mounted (MHNG, NHMB, USNM).

Material not included in type series. **Chile:** galls on leaves of *Schinus patagonicus*, same data as holotype.

***Calophya rubra* (Blanchard)**

(figures 8G–L, 19, 61)

Calinda rubra Blanchard, 1852: 312. Lectotype ♀, Chile: Coquimbo (MNHN), examined; designated by Burckhardt, 1988: 119

Psyllid gall nr. 1, Kieffer and Herbst, 1905: 65; 1906: 234: plate I, figures 7, 8
Calophya rubra (Blanchard); Burckhardt, 1988: 119

Description. Adult. Coloration. Head and body dark brown to black. Intersegmental membranes reddish brown. Forewings colourless, transparent, veins brown. Young specimens lighter with more extended ochreous and reddish coloration darkening gradually.

Structure. Anterior portion of vertex covered in very short and inconspicuous setae; genal processes long, slender, contiguous in the middle. Forewings (figure 8G) oblong-oval, widest in the middle, irregularly rounded apically; surface spinules absent apart from cell cu_2 . Genitalia as in figure 8H–L. Male subgenital plate short; proctiger thick, rounded posteriorly; paramere lamellar, long, truncate apically; distal portion of aedeagus straight, long, with large apical dilatation. Female proctiger with long pointed apical process; subgenital plate with long, subacute apical processes.

Measurements in mm (5 ♂, 9 ♀). HW 0.60–0.72; AL 0.48–0.72; WL 1.93–2.45; MP 0.24–0.27; PL 0.18–0.19; AA 0.22–0.25; FP 0.43–0.61; VL/GL 0.95–1.22; AL/F1 2.00–3.05; AL/HW 0.69–1.18; WL/HW 3.06–3.70; WL/WW 2.14–2.46; a/b 1.28–1.63; c/d 0.67–1.05; TL/HW 0.68–0.82; MP/HW 0.38–0.43; AB/AA 0.92–1.09; FP/HW 0.62–0.87; FP/SL 0.98–1.42; FP/CL 3.59–4.45; FP/FA 1.95–2.90.

Fifth instar larva (figure 19). Yellow, dorsal sclerites ochreous to brown. Anterior margin of head weakly concavely rounded, not cleft in the middle. Antennae straight, without sectasetae. Legs with claws. Anterior margin of humeral lobes level with posterior eye margin. Abdominal dorsum with median row of horns. Caudal plate ratio 0.53. Circumanal ring circular. Head margin with short thick setae; wing bud margin without specialized setae; abdominal margin with very slender and long lanceolate setae.

Host plant, gall and biology. *Schinus polygamus*. Inducing nut galls on twigs and branches (figure 61). Sometimes several galls fused together but each gall contains one chamber with one larva. Before emergence of the adult the gall measures 3–4 mm in diameter bearing a few hairs around the opening pore. The gall may be fleshy or woody. The gall was described and illustrated by Kieffer and Herbst (1905, 1906), and by Nuñez and Sáiz (1994, nr. 51-2, figure 24).

Distribution. Chile (Regions IV–VIII and Metropolitana). Reported from Coquimbo (Blanchard, 1852) and from ‘Quinamarida near Linares between Valparaiso and Santiago’ [sic] (Kieffer and Herbst, 1905, 1906), and from the La Campana National Park (Sáiz and Nuñez, 1977) (see also comments). The species has probably a bivoltine life cycle (Sáiz and Nuñez, 1977).

Material examined. **Chile:** IV Region, 1 ♀, lectotype of *Calinda rubra*, Coquimbo; V Region, 20 ♂ and ♀, Province Quillota, La Campana National Park, 1300 m, 11.i.1985, *Schinus* sp. (D. Hollis); 54 first to third instar larvae, same data but La Campana National Park, Sector Ocoa, 400–500 m, 9.viii.1993, from from nut galls on twigs and branches of *Schinus polygamus* (F. Sáiz); ca 30 second to fifth instar larvae (mostly larger instars), same data but 6.ix.1993; 20 third to fifth instar larvae, same data but 25.x.1993; ca 20 first and second instar larvae; same data but 6.xii.1993; 20 first and 1 third instar larvae, same data but 25.i.1994; ca 60 first instar larvae, same data but 7.iv.1994; ca 40 second to fourth instar larvae, same data but 30.v.1994; ca 30 second to fifth instar larvae, same data but 12.vii.1994; 54 first to fifth instar larvae (mostly larger instars), same data but 16.viii.1994; ca 40 second to fifth instar

larvae (mostly larger instars), same data but 12.ix.1994; 23 fifth instar larvae, same data but 10.x.1994; 40 second instar larvae, same data but 12.xii.1994; larvae from nut galls on twigs, Province San Felipe, Termas de Jahuel, 1000 m, 21.i.1997, *Schinus polygamus* (D. Burckhardt); 1 ♀, Province Los Andes, near Portillo Ski Centre, Guardia Veja, 21.x.1995, on branches of *Schinus polygamus* (R. Muñoz G.); Region Metropolitana: 2 ♂, 2 ♀, Province Santiago, Tiltil, Cuesta La Dormida, 5.xi.1965 (P. Balogh); VI Region, 4 larvae from nut galls on twigs, Province Colchagua, La Rufina, Río Tinguiririca, 650 m, 11.i.1996, *Schinus polygamus* (D. Burckhardt); nut galls on twigs of *Schinus polygamus*, same data but Bellavista, Río Claro, 900 m, degraded deciduous forest; VII Region, 13 ♂, 10 ♀, 5 larvae, galls on branches and twigs, Province Talca, Armerillo to Las Garzas, Valle Maule, 700 m, 35°45'S 71°00'W, 25.xi.1992, *Schinus polygamus* (D. Burckhardt); larvae from nut galls on twigs, same data but Province Cauquenes, 10 km W Cauquenes, 400 m, 12.ii.1996, open degraded scrub; larvae and galls on twigs, same data but Province Linares, 10 km W Parral, 400 m, 12.ii.1996; VIII Region, 13 ♂, 16 ♀, 3 larvae, nut galls on twigs, Province Concepción, Escuadrón, 15 km S Concepción, 36°56'S 73°09'W 50 m, 10.xii.1992 (D. Burckhardt); 3 ♂, 10 ♀, nut galls on the twigs, same data but Escuadrón, 15 km S Concepción, 20 m, 17.i.1996; nut galls on twigs of *Schinus polygamus*, same data but Province Biobío, Laguna del Laja National Park, sector Chacay, 1200 m, 19.i.1996, *Austrocedrus* forest and open sclerophyll scrub; nut galls on twigs of *Schinus polygamus*, same data but sector Lagunillas, 1100 m, 21.i.1996, open *Austrocedrus* forest and sclerophyll scrub. Dry and slide mounted, and preserved in alcohol (BMNH, HNHM, MHNG, MHNS, MNHN, NHMB, UCVA, USNM).

Comments. The distribution records of *C. rubra* given by Burckhardt (1988) concern a mixture of species.

***Calophya schini* Tuthill, stat. rev.**

(figures 9A–E, G, 20, 62)

Psyllid gall, Rübsaamen, 1899: 277, figure 17; 1908: 77, figure 16. Larvae, Bolivia: Cochabamba, iv.1892, in pit gall on leaf of *Schinus molle* (O. Kunze) (MNHU)

Calophya schini Tuthill, 1959: 5. Holotype ♂, Peru: La Cantuta, 6.x.1958, *Schinus molle* (USNM), examined

Description. Adult. Coloration. Head and body green or yellow. Antennae dark brown. Genal processes whitish. Thoracic dorsum with orange to brown pattern. Abdomen brown. Fore and midlegs greyish brown. Forewings colourless, transparent, veins brown. Dark colour in young specimens reduced.

Structure. Anterior portion of vertex covered in short setae which are about as long as distance between them; genal processes moderately long, slender, contiguous in the middle. Forewings (figure 9A) oval, widest in apical third, evenly rounded apically; surface spinules present in all cells leaving broad spinule-free stripes along the veins. Genitalia as in figure 9B–E, G. Male subgenital plate short; proctiger thick, rounded posteriorly; paramere lamellar, short, obliquely truncate apically, anterior inner apical tooth large; distal portion of aedeagus weakly curved, with oblong apical dilatation. Female proctiger with relatively short pointed apical process; subgenital plate with relatively short, subacute apical processes.

Measurements in mm (6 ♂, 6 ♀). HW 0.49–0.64; AL 0.50–0.63; WL 1.74–2.20; MP 0.14–0.20; PL 0.11–0.11; AA 0.14–0.16; FP 0.27–0.32; VL/GL 0.94–2.00; AL/F1 2.24–3.15; AL/HW 0.88–1.11; WL/HW 3.11–3.68; WL/WW 2.24–2.77; a/b

1.50–2.00; c/d 0.79–1.15; TL/HW 0.59–0.74; MP/HW 0.27–0.38; AB/AA 0.94–1.21; FP/HW 0.47–0.57; FP/SL 0.90–1.33; FP/CL 2.07–3.56; FP/FA 2.58–3.56.

Fifth instar larva (figure 20). Anterior margin of head forming two large lobes. Antennae S-shaped, with sectasetae. Legs with claws. Anterior margin of humeral lobes ending distal to anterior eye margin. Abdominal dorsum without median row of horns. Caudal plate ratio 0.40. Circumanal ring oval. Head, wing bud and abdominal margins with sectasetae.

Host plant, gall and biology. *Schinus molle*. Inducing pit galls on the leaves (figure 62), petioles, twiglets and flower buds (Downer *et al.*, 1988; Rübсаamen, 1899, 1908; Tuthill, 1959). When heavily attacked the leaves become distorted and drop prematurely. Galls and larvae were described and illustrated by Rübсаamen (1899, 1908), Downer *et al.* (1988) and Nuñez and Saiz (1994, nr. 49, figure 20). Eggs are laid on several types of tender new growth. Based on the presence of eggs and adults, Downer *et al.* (1988) suggested that reproduction may take place year-round but that the population size varies with tree phenology.

Distribution. Bolivia (Cochabamba), Peru (Ancash, Cuzco, Huánuco, Lima, Tacna), and introduced into Argentina (Jujuy, Mendoza, Salta), Chile (Regions I–V, Metropolitana), New Zealand and USA (California). Reported from Bolivia (Rübсаamen, 1899, 1908), Peru, Chile (Tuthill, 1959) and California (Downer *et al.*, 1988).

Material examined. **Argentina:** deep pit galls on the leaflets and leaf pedicels, Province Jujuy, Maimara, v.1873, *Schinus molle* (Lorentz and Hieronymus); 1 ♀, Province Mendoza, 18 km Mendoza to Villa Vicencia, 700 m, 18.i.1997, *Schinus molle* (D. Burckhardt); 9 adults and larvae, same data but Mendoza Valley, Potrerillos to Cacheuta, 1200 m, 17.i.1997; ca 100 adults, same data but Villa Hodel, 7 km on road Cacheuta to Mendoza, 1100 m, 17.i.1997; 20 ♂, 27 ♀, Mendoza, Zoological Garden, vii.1997 (S. Roig); pit galls on the leaves, Province Salta, Departamento Santa Victoria, Santa Victoria, 2385 feet, 1.ii.1943, *Schinus molle* (T. Meyer). **Bolivia:** larvae, Cochabamba, iv.1892, in pit gall on leaf of *Schinus molle* (O. Kunze); pit galls on the leaves, Cochabamba, Parotani, 18°00'S 66°30'W, 840 feet, 10.vii.1949, *Schinus molle* (W. M. A. Brooke); pit galls on the leaves, Larecaja, NL. Sorata, 15°47'S, 68°40'W, San Pedro, 2650 m, 9.i.1978, *Schinus molle*; pit galls on leaves, Capi, iii.1890, *Schinus molle* (Britton and Rusby). **Chile:** I Region, 1 ♂, 1 ♀, Arica, 29.i.1968, *Schinus molle* (A. Abenteca and P. López); 1 ♂, Tarapacá, Tilivichi, 8.ii.1994 (L. E. Peña and A. Ugarte); II Region, 3 ♂, 2 ♀, Antofagasta, 25.ii.1947, *Schinus molle* (G. Olalquiaga F.); 3 ♂, 1 ♀, Lasana, 2590 m, 22°18'S 68°48'W, vii.1997, *Pluchea absinthoides* (F. Sáiz); III Region, 3 ♂, 7 ♀, Province Copiapo, Copiapo, 27°20'S 70°18'W, 300 m, 7.xii.1993, *Schinus molle* (D. Burckhardt); 37 adults, same data but Quebrada de Paipote, 70 km NE Copiapo, 27°09'S 69°54'W, 1800 m, 12.xii.1993; 1 ♀, Province Huasco, 14 km E Vallenar, 22.ii.1985, *Schinus* sp. (D. Hollis); 2 ♂, 4 ♀, same data but 35 km E Vallenar, 22.ii.1985, *Schinus molle*; IV Region, 51 ♂, 53 ♀, 2 larvae and pit galls on the leaves, Province Elqui, Valle Elqui near Rivadavia, 750 m, 20.xii.1995, *Schinus molle* (D. Burckhardt); 1 exuvia, same data but ca 40 km E La Serena, 5 km SW Viñita Baja, 450 m, 19.xii.1995; 1 ♀, same data but 15 km SW Viñita Baja, 29°50'S 70°50'W, 450 m, 4.xii.1993; 6 ♂, 13 ♀, same data but 15–25 km S Vicuña, 30°15'S 70°40'W, 1300–1700 m, 14.xii.1993; 16 adults, pit galls on the leaves, same data but 10 km S Vicuña to Hurtado, 900 m, 18.xii.1995; pit galls on leaves, Vicuña, 25.xi.1951, *Schinus molle* (J. Frödin); 10 ♂, 11 ♀, same data but Coquimbo, Hurtado, 19.ii.1985, *Schinus*

molle (D. Hollis); 121 adults and larvae, and pit galls on leaves, Province Limarí, Fray Jorge National Park, 250 m, 7–9.xii.1990, mediterranean scrub (D. Agosti and D. Burckhardt); 4 ♂, 5 ♀, same data but 30°40'S 71°40'W, 100 m, 14–16.xii.1992; 4 ♀, same data but Quebrada La Vaca, 30°40'S 71°40'W, 100–200 m; V Region, ca 80 adults and larvae, pit galls on the leaves, Province Quillota, Quillota, La Palma, 300 m, 25.xii.1995, *Schinus molle* (D. Burckhardt); 1 ♂, pit galls on leaves, same data but 15.i.1996; 7 ♂, 4 ♀, same data but La Calera, 32°47'S 71°12'W, 100 m, 15.xi.1992; 18 ♂, 17 ♀, eggs and larvae, same data but Province San Felipe, La Calera, 300 m, 26.xii.1995; 14 adults, same data but Termas de Jahuel, 1000 m, 21.i.1997; 3 ♀, same data but *Schinus polygamus*; Region Metropolitana: 3 ♀, Santiago, Parque Metropolitano, 22.ix.1982, on ornamental plants; 1 ♂, 4 ♀, 6 larvae, pit galls on leaves, same data but 3.xii.1990, *Schinus molle* (D. Agosti); 2 ♂, 2 ♀, Santiago, Maipo, 22.x.1989, *Schinus molle* (M. Elgueta); 39 adults, 40 km on Carretera 78, Isla de Maipo, 4.v.1993, *Schinus molle* (D. Burckhardt). **New Zealand:** 10 ♂, 4 ♀, 17 larvae, Auckland, 3.vii.1989, *Schinus molle* (P. J. Dale). **Peru:** PARATYPES 1 ♂, 1 ♀, Lima, Rimac Valley, 19.xii.1958 (L. D. Tuthill); 34 ♂, 28 ♀, Cuzco, Lucre, 30 km S Cuzco, 3550 m, 4.viii.1971 (C. M. Vardy); 4 ♂, 4 ♀, Tacna, Calientes, 1200 m, 10.ii.1994 (L. E. Peña and A. Ugarte). **USA:** California, 3 ♂, 5 ♀, Los Angeles County, Inglewood, 18.x.1984, *Schinus molle* (Penrose); adults, larvae and pit galls on the leaves, same data but Lakewood, 3.i.1985 (D. Sulentic); adults, larvae and pit galls on the leaves, same data but Los Angeles, 18.x.1984 (Penrose); adults and pit galls on the leaves, same data but I405 at Ohio Street, Westwood Park, 5.x.1984; 2 ♂, 1 ♀; Napa County, Napa, 24.iii.1987, *Schinus molle* (King) 4 ♂, 2 larvae, Orange County, Fullerton, 10.viii.1984, *Schinus molle* (D. Byers); 10 larvae, same data but 19.vii.1984; adults, larvae and pit galls on the leaves, same data but Long Beach, 18.vii.1984 (M. Miller); 4 ♂, 3 ♀, 14 larvae, Riverside County, Corona, 12.xii.1986, *Schinus molle* (Reaves and Chandler); 3 ♂, 2 ♀, Rosemead Co. Q. at Visalia, 20.iii.1987, *Schinus molle* (R. D. Haines, M. DeShon and R. Rainey); 1 ♂, 7 larvae, San Bernardino County, Lompoc, 31.i.1985, *Schinus molle* (Janssen and Davidson); larvae and pit galls on the leaves, San Diego County, Rancho Santa Fe, 23.i.1987, *Schinus molle* (H. Metcalf); 1 ♀, San Luis Obispo County, 17.xii.1986, *Croton* sp. (Smithback); adults, larvae and pit galls on the leaves, Sonora County, Santa Rosa, 2.vi.1987, *Schinus molle* (J. Joos); 6 ♂, 4 ♀, Ventura County, Camarillo, 17.vii.1985 (Penrose); 1 ♀, same data but Fillmore, 19.viii.1985; 8 ♂, 7 ♀, same data but Ventura, 18.x.1984; larvae and pit galls on the leaves, same data but 3.x.1984. Dry and slide mounted, and preserved in alcohol (BMNH, DFAS, IAIM, HNHM, MHNG, MHNS, MNHN, MNHU, NHMB, UCVA, USNM).

Calophya scrobicola sp. n.

(figures 9F, H–K, 21)

Description. Adult. Coloration. Head and body green or yellow. Antennal flagellum dark brown. Genal processes yellow. Vertex and thoracic dorsum with brown pattern. Apical tarsal segments brown. Forewings yellowish, transparent, veins of similar colour as membrane. Dark colour in young specimens reduced.

Structure. Anterior portion of vertex covered in short setae which are about as long as distance between them; genal processes long, slender, contiguous in the middle. Forewings (figure 9F) oval, widest in apical third, evenly rounded apically; surface spinules absent apart from base of cell cu₂. Genitalia as in figure 9H–K.

Male subgenital plate short; proctiger relatively slender, curved posteriorly; paramere lamellar, relatively slender, obliquely truncate apically; distal portion of aedeagus weakly curved, with large apical dilatation. Female proctiger with long pointed apical process; subgenital plate with long, subacute apical processes.

Measurements in mm (3 ♂, 2 ♀). HW 0.42–0.49; AL 0.34–0.46; WL 1.36–1.62; MP 0.15–0.15; PL 0.10–0.13; AA 0.13–0.16; FP 0.34–0.36; VL/GL 0.94–1.45; AL/F1 2.27–2.71; AL/HW 0.76–0.98; WL/HW 3.08–3.45; WL/WW 2.09–2.19; a/b 1.33–1.60; c/d 0.69–0.83; TL/HW 0.61–0.74; MP/HW 0.31–0.33; AB/AA 0.88–1.07; FP/HW 0.69–0.77; FP/SL 1.03–1.16; FP/CL 3.00–3.40; FP/FA 2.13–2.40.

Fifth instar larva (figure 21). Yellow with very slightly darker dorsal sclerites. Anterior margin of head forming two large lobes. Antennae S-shaped, bearing sectasetae. Legs with claws. Anterior margin of humeral lobes level with the middle of eye margin. Base of wing buds and abdomen with rows of dorsal horns. Caudal plate ratio 0.55. Circumanal ring oval. Head, wing bud and abdominal margins with sectasetae.

Host plant, gall and biology. *Schinus polygamus*. In pit galls on the leaves.

Distribution. Chile (VI–VIII Regions).

Material examined. HOLOTYPE ♂, **Chile:** VIII Region, Province Concepción, Escuadron, 20 km S Concepción, 20 m, 17.i.1996, *Schinus polygamus* (D. Burckhardt), dry mounted (MHNG).

PARATYPES. **Chile:** VI Region, 2 ♀, Province Colchagua, La Rufina, Río Tinguiririca, 650 m, 11.i.1996, *Schinus polygamus* (D. Burckhardt); VII Region, 1 ♀, 1 exuvia, Province Cauquenes, 10 km W Cauquenes, 400 m, 12.ii.1996, *Schinus polygamus* (D. Burckhardt); VIII Region, 25 ♂, 10 ♀, same data as holotype; 4 ♂, 3 ♀, 4 larvae, same data but 15 km S Concepción, 36°56'S 73°09'W, 50 m, 10.xii.1992; 3 ♂, 6 ♀, same data but Province Ñuble, near Recinto, ca 60 km E Chillan, 400–600 m, 12.xii.1990, Valdivian forest (D. Agosti and D. Burckhardt); 1 ♂, 5 ♀, same data but 20 km on Road Cabrero to Yungay, 300 m, 18.i.1996 (D. Burckhardt); 2 ♂, 2 ♀, Province Biobío, Laguna del Laja National Park, sector Lagunillas, 1100 m, 21.i.1996, *Schinus polygamus* (D. Burckhardt); 1 ♂, 1 ♀, Laguna del Laja National Park, 19.i.1985, *Schinus* sp. (D. Hollis). Dry and slide mounted and preserved in alcohol (BMNH, MHNG, MHNS, NHMB).

Material not included in type series. **Chile:** VIII Region, pit galls on leaves, Province Concepción, Escuadron, 15 km S Concepción, 36°56'S 73°09'W, 50 m, 10.xii.1992, *Schinus polygamus* (D. Burckhardt); pit galls on leaves, Province Ñuble, 20 km on Road Cabrero to Yungay, 300 m, 18.i.1996, *Schinus polygamus* (D. Burckhardt); pit galls on leaves, near Recinto, ca 60 km E Chillan, 400–600 m, 12.xii.1990, Valdivian forest (D. Agosti and D. Burckhardt). Dry mounted and preserved in alcohol (MHNG).

Calophya terebinthifolii sp. n.

(figures 10, 22)

?*Calophya* sp., Costa Lima, 1942: 97, figures 114, 115. Brazil: pit galls on the leaves of *Schinus terebinthifolius* (depository?).

Description. Adult. Coloration. Head and thorax dark brown to almost black, shiny. Genal processes, and antennae whitish, except for the two apical antennal segments which are dark brown to black. Legs brown with yellowish tibiae and tarsi. Forewings transparent or weakly yellowish; veins yellowish, vein C + Sc dark

brown. Abdomen including genitalia greenish to yellowish, strongly contrasting with head and thorax.

Structure. Anterior portion of vertex covered in very short, inconspicuous setae; genal processes long, slender, contiguous in the middle. Forewings (figure 10A) oblong-oval, broadly rounded apically; surface spinules present in all cells, leaving broad, spinule-free stripes along the veins. Genitalia as in figure 10B–F. Male subgenital plate short; proctiger relatively slender; paramere lamellar, short; distal portion of aedeagus short with apical dilatation about half as long as segment. Female proctiger short, clavate in profile; subgenital plate subacute apically.

Measurements in mm (1 ♂, 1 ♀). HW 0.44–0.46; AL 0.45–0.49; WL 1.28–1.50; MP 0.14; PL 0.08; AA 0.10; FP 0.22; VL/GL 1.21–1.290; AL/F1 1.96–2.72; AL/HW 1.02–1.07; WL/HW 2.91–3.26; WL/WW 2.50–2.72; a/b 1.19–1.28; c/d 0.73–0.97; TL/HW 0.77–0.85; MP/HW 0.32; AB/AA 0.90; FP/HW 0.48; FP/SL 1.05; FP/CL 2.20; FP/FA 2.44.

Fifth instar larva (figure 22). Anterior margin of head forming two large lobes. Antennae irregularly triangular, with sectasetae. Legs with very small claws. Anterior margin of humeral lobes ending distal to anterior eye margin. Abdominal dorsum without median row of horns. Caudal plate ratio 0.46. Circumanal ring oval. Head, wing bud and abdominal margins with sectasetae.

Host plant, gall and biology. *Schinus terebinthifolius*. Inducing pit galls on the leaves. The galls and larvae described and illustrated by Costa Lima (1942) probably concern *C. terebinthifolii*. Among the material at hand are larvae of Syrphidae and Neuroptera which are likely predators of the calophyid larvae. The latter are also parasitized by Hymenoptera.

Distribution. Brazil (Paraná, Sao Paulo), Paraguay (Alto Paraná).

Material examined. HOLOTYPE ♂, **Brazil**: Sao Paulo, Maua, iv.1961, *Schinus terebinthifolius* (N. L. H. Krauss), dry mounted (USNM).

PARATYPES. **Brazil**: 1 ♂, 2 ♀, same data as holotype; 6 ♂, 13 ♀, same data as holotype but 16.iv.1961; 1 ♂, 1 ♀, 7 larvae, Paraná, Castro, 5.ii.1988, on leaves of *Schinus terebinthifolius* (Bennett and Habeck); 56 adults, same data but 16.ii.1989, on young foliage of *Schinus terebinthifolius* (F. D. Bennett, D. H. Habeck and C. Crestana); 114 adults, ca 40 larvae, same data but 18.ii.1989, on leaves of *Schinus terebinthifolius*; ca 20 adults and larvae in pit galls on the leaves, same data but 6.ii.1989 (F. D. Bennett and C. Crestana). Dry and slide mounted, and preserved in alcohol (BMNH, NHMB, USNM).

Material not included in type series. **Paraguay**, pit galls on the leaves, Alto Paraná, 1909/1910, *Schinus terebinthifolius* (K. Fiebrig) (BMNH).

Unidentified species

Calophya sp.

Psyllid gall, Tavares, 1915: 122. Argentina: Buenos Aires, Botanical Garden, galls on the leaves of *Schinus polygamus* (H. Moliné) (depository?)

According to Tavares' (1915) description the galls are similar to those of *C. orbicola*.

?*Calophya* sp.

Psyllid gall, Karsch, 1880: 305, figure 16. Brazil: Porto Alegre, nipple galls on the leaves of a plant tentatively referred to a Sapotaceae close to *Argania sideroxylon* R. S. (depository?); Rübsaamen, 1899: 276; Houard, 1933: 208, gall nr. 589

Karsch (1880) suggested that the galls may have been produced by Hymenoptera: Tenthredinidae. Rübssaamen (1899) who examined the same material found psylloid larvae associated with the galls. Houard (1933) without giving further information referred the plant to *Schinus dependens*. Judging from Karsch's drawing the gall could come from a *Calophya* sp.

Calophya spp.

An additional source of information on *Calophya* galls provided herbarium specimens deposited in the BMNH and CJBG. Below the galls are listed which could not be associated with named *Calophya* spp.

Schinus andinus (Engler) Johnston: flat nipple galls on the leaves, **Bolivia**: Departamento La Paz, on South side at Calacito, 16°32'S 68°05'W, 3300–3600 m, 20.i.1982 (J. C. Solomon) (CJBG). *Schinus bumelioides* Johnston: flat nipple galls on the leaves, **Argentina**: San Luis, Pedernera, FCP, 430 m, 29.ix.1927 (BMNH); flat nipple galls on the leaves, **Argentina**: Tucuman, Traneras, Trapia, 700 m, 18.viii.1929 (S. Venturi) (BMNH); larval skins and elongate nipple galls on the leaf margin similar to *C. gallifex*, **Argentina**: Salta, Metán, Río Juramento, 26.4 km E 'Cabra Corral', 800 m, 24.x.1986 (L. Novara) (CJBG). *Schinus engleri* Barkley: hemispherical nipple galls on the leaves, **Brazil**: Santa Catharina, Serra da Boa Vista, São José, 1000 m, 11.viii.1980 (Reitz and Klein) (CJBG); shallow pit galls on the leaves with large discoloured aureole, **Brazil**, Santa Catharina, Campo Alegre, 900 m, 6.ix.1957 (CJBG). *Schinus fasciculatus* (Griseb.) Johnston: very flat disk-shaped nipple galls on the leaves, **Argentina**: Cordoba, Estancia Germania, vi–xii.1874 (P. G. Lorentz) (BMNH); very flat, disk-shaped galls on the leaves, **Argentina**: Santiago del Estero, Zanjón, 27°55'S 64°15'W (Herbarium John Miers, bequeathed 1879) (BMNH); nipple galls and pit galls on the leaves, **Argentina**: Jujuy, Departamento Tumbaya, Quebrada de Coirruro, 2–3 km N Volaca, 2050–2150 m, 29.xii.1989 (L. Novara and S. Bruno) (CJBG); conical nipple galls similar to *C. gallifex*, **Argentina**: Cordoba, Estancia San Teodoro, Río I. 25.iv.1896 (Stuckert) (CJBG); pit galls on the leaves surrounded by large discoloured ring, **Argentina**: Corrientes, Departamento Capital, Ruta 5, 62 km SE Corrientes, 18.iii.1975 (A. Shinini) (CJBG); flat nipple galls on the leaves, **Argentina**: Salta, La Viña, Paraje Entre Ríos, 7 km W La Viña, 14.xii.1985 (L. Novara) (CJBG); pit galls with discoloured ring, **Argentina**: La Viña, 3.xii.1983 (L. Novara) (CJBG); pit galls and larvae similar to *C. scrobicola*, **Argentina**: Chaco, Departamento General San Martín, Ruta provincial 90 km 1092, Estancia La Florida, 10.iv.1993 (G. E. Prieszko) (CJBG); pit galls on the leaves, **Paraguay**: Gran Chaco: Santa Elisa, 23°10'S, 1903? (Hassler) (BMNH); pit galls on the leaves, **Paraguay**: Presidente Hayes, 82 km Ruta trans-Chaco, 3.iv.1991 (F. Mercles) (CJBG). *Schinus ferox* Hassler: larvae and flat pit galls similar to *C. clavuligera*, **Brazil**: RS, São Francisco de Paula, 800 m, 10.vi.1991 (M. Laner *et al.*) (CJBG); globular nipple galls, **Brazil**: RS, Caxias do Sul-Ana Rech-Faxinal, 18.viii.1989, 750 m (R. Wasum) (CJBG). *Schinus gracilipes* Johnston: flat nipple galls on the leaves, **Argentina**: Catamarca, El Candado, 2700 m, 2.ii.1916 (Jørgensen) (CJBG); flat nipple galls on the leaves, **Argentina**: Salta, Departamento Capital, San Lorenzo, Filo de cerrosal oeste de la quebrada, 2000–2200 m, 29.x.1988 (L. Novarra) (CJBG); nipple galls on the leaves, **Argentina**: Salta, Candelaria, Sierra de la Candelaria, 1700 m, 23.ix.1929 (CJBG); flat nipple galls on the leaves, **Argentina**: Salta, Santa Victoria, Los Toldos, Quebrada del Nogal, 1600–1900 m, 19.iii.1986

(L. Novara) (CJBG); flat nipple galls on the leaves and pit galls on the leaves, **Argentina**: Tucuman, Zeaí, Cumbredi Raco, 2000 m, 11.xi.1929 (BMNH). *Schinus johnstonii* Barkley: pit galls on the leaves, **Argentina**: Río Negro, Departamento General Roca, Chichinales, 6.xi.1972 (A. Kvapovickas *et al.*) (CJBG). *Schinus lentiscifolius* March: larvae and pit galls on the leaves, **Brazil**: Rio Grande do Sul, 1835 (M. Isabelle) (CJBG); pit galls on the leaves, **Uruguay**: Lavalleja, Penitente, 200 m, 20.i.1935 (W. G. Herter) (CJBG). *Schinus longifolius* (Lindl.) Speng.: elongate, upright nipple galls on the leaf margins similar to those of *C. gallifex*: **Argentina**: Chaco, Orillas montes Mboreri, Río Guaycurú, 17.vii.1944 (F. Rojas) (BMNH); larvae and pit galls on the leaves similar to *C. clavuligera*, **Brazil**: Rio Grande do Sul, Encrusilhada do Sul, 11.ii.1948 (Palacios-Cuezzo) (CJBG); pit galls on the leaves, **Paraguay**: in regione calcarea cursus superioris fluminis Apa, iii.1912/1913 (E. Hassler) (CJBG); pit galls and flat nipple galls on the leaves, **Paraguay**: Campichuelo, Orilla Mountain, Nacho Caracol Marguerita, iii.1912/1913 (E. Hassler) (CJBG); large globular galls on the leaves, **Paraguay**: Amambay, Pedro Juan Caballero, 740, 350 m, 26.iii.1951 (G. J. Schwarz) (CJBG); flat nipple galls on the leaves, **Paraguay**: in regione calcarea cursus superioris fluminis Apa, Cerro Margarita, iii.1912/1913 (E. Hassler) (BMNH); pit galls on the leaves, **Uruguay**: Montevideo, Botanical Garden, x.1925 (CJBG). *Schinus marchandii* Barkley: pit galls on the leaves, **Argentina**: Chubut, Escalante, Canadon Pilar, Estancia Los Manatales, 60 km N Comodoro Rivadavia, 300 m, 24.xii. (CJBG); nipple galls on the leaves, **Argentina**: Santa Cruz, Puerto San Julian, vii.1925 (E. Blake) (BMNH); flat nipple galls on the leaves, **Argentina**: Río Negro, Departamento Los Lagos, Nahuel Huapi, road to Bariloche, 250 m, 3.xii.1950 (O. Boelcke) (CJBG). *Schinus meyeri* Brakley: flat, disk-shaped nipple galls on the leaves, **Argentina**: Salta, Santa Victoria Los Toldos, 1700–1900 m, 2.xi.1989 (L. J. Novara) (CJBG). *Schinus myrtifolius* (Griseb.) Cabrera: larvae in pit galls and flat nipple galls on the leaves, **Argentina**: Jujuy, Ledesma, Abra de Cañas, 1600 m, 8.xi.1974 (A. Krappovickas *et al.*) (CJBG); larvae and pit galls on the leaves similar to *C. terebinthifolii*, **Argentina**: Salta, Caldera (H. Sleumer *et al.*) (CJBG); nipple galls on the leaves, **Bolivia**: La Paz, Inquisivi, 16°43'S 16°14'W, 21–22.ii.1989 (M. Lewis) (CJBG). *Schinus piliferus* Johnston: pit galls on the leaves, **Argentina**: Salta, La Caldera, Cuesta del Gallinato, 1300–1500 m, 10.x.1987 (L. J. Navaro) (CJBG); pit galls on the leaves: **Argentina**: Tucuman, 450 m, 1.xi.1906 (CJBG). *Schinus venturii* Barkley: pit galls and flat nipple galls on the leaves, **Argentina**: Jujuy, Capital, Lagunes de Yola, 4.i.1971 (A. Krapovickas *et al.*) (CJBG).

Rhinocolinae

The systematics and biology of the Rhinocolinae were discussed by Burckhardt and Lauterer (1989) who provided keys to the constituent taxa. Park (1996) synonymized *Koreaphalara* Kwon with *Rhusaphalara* Park and Lee which he referred to the Rhinocolinae. Here we add also *Notophyllura* Hodkinson from the Euphyllurinae and '*Paurocephala*' *longicella* (cf. discussion below), and provide keys for the New World taxa.

Keys to New World Rhinocolinae

Adults

- 1 One subapical rhinarium present on each of antennal segments 4–9 (for description and distributional data cf. Burckhardt and Lauterer, 1989).
 *Ameroscena mexicana* Burckhardt and Lauterer

- At most 4 rhinaria present on antenna (if 10 segments developed, one on each of segments 4, 6, 8 and 9). 4
- 2 Forewing with costal break (figure 25A, I). Frons very short, wider than long (figure 25G). Clypeus pear-shaped in out-line, flattened. *Tainarys* 3
- Forewing without costal break (figure 23A). Frons long, distinctly longer than wide (figure 23C). Clypeus heart-shaped. 8
- 3 Apex of vein Rs of forewing curved towards foremargin (figure 25I). Female subgenital plate truncate apically, densely haired ventrally (figure 26D). 4
- Apex of vein Rs of forewing straight or curved backwards, ending at outer wing margin (figure 25A). Female subgenital plate pointed apically, sparsely setose ventrally (figure 25C) 6
- 4 Forewings with cross-veins between $Rs-M_{1+2}$ and $M_{3+4}-Cu_{1a}$ respectively (figure 25I). Genitalia as in figure 26. *T. venata* sp. n.
- Forewings without cross-veins. Genitalia different. 5
- 5 Male paramere bent backwards from the middle; inner face bearing 9–12 strongly sclerotized black pegs. Female subgenital plate with 3–5 transverse rows of densely spaced setae at base which strongly contrast with the other setae. *T. schini* Brèthes
- Male paramere bent backwards in apical third; inner face bearing 5–8 strongly sclerotized black pegs. Female subgenital plate with dense basal setosity which becomes gradually sparser towards apex. *T. sordida* Burckhardt
- 6 Forewings bearing pattern consisting of brown, well-defined spots; vein C + Sc weakly concave. Paramere broadly angular; inner face with a group of bristle-like setae near apical half along hind-margin. Female proctiger short, $FP/HW < 0.7$ *T. inopinata* (Burckhardt)
- Forewings yellow or brown without well-defined brown spots; vein C + Sc straight (figure 25A). Paramere lamellar; inner face with rows of strongly sclerotized, black pegs near fore-margin in apical half (figure 25D). Female proctiger long, $FP/HW > 0.7$ 7
- 7 Body entirely ochreous to brown, forewings brownish. Meso and metascutellum flattened *T. acuticauda* Burckhardt and Lauterer
- Head and thorax dark, with reddish, yellowish and white spots, abdomen yellowish to greenish, forewings light to dark yellow. Meso and metascutellum distinctly raised. Genitalia as in figure 25B–E. *T. maculipectus* sp. n.
- 8 Forewings with notch at apex of vein C + Sc (for descriptions, keys to species and locality data cf. Hodkinson, 1986) *Notophyllura* Hodkinson
- Forewings without notch at apex of vein C + Sc (figure 23A). *Leurolophus* 9
- 9 Outer anterior vertex margin oblique. Forewings with wide light brown marginal band, black streak on vein M + Cu_1 short, less than half length of vein. Metacoxae with moderately large, tubular, blunt process on the trochanteral cavity (figure 23I). Male paramere strongly widening in apical half. Dorsal margin of female proctiger convex *L. vittatus* Tuthill
- Outer anterior vertex margin angular (figure 23B). Forewings with narrow dark brown submarginal band, black streak on vein M + Cu_1 long, more than half length of vein (figure 23A). Metacoxae with large, tubular, pointed process on the trochanteral cavity (figure 23H). Male paramere lamellar (figure 23E). Dorsal margin of female proctiger concave (figure 23G) *L. oriformae* sp. n.

Last instar larvae

(larvae of *Ameroscena* and *Tainarys inopinata* unknown)

- 1 Anus terminal (figure 24). 2
- Anus ventral (figure 27). *Tainarys* 4
- 2 Apex of tibiotarsus curved, claw-shaped. Caudal plate rounded posteriorly. *Notophyllura* Hodkinson

- Apex of tibiotarsus straight, bluntly rounded. Caudal plate truncate posteriorly (figure 24). *Leurolophus* 3
- 3 North America *L. vittatus* Tuthill
- South America *L. oriformae* sp. n.
- 4 Caudal plate broadly rounded posteriorly (figure 29). 5
- Caudal plate angular or ending in short process posteriorly (figure 27). 6
- 5 Forewing buds with few marginal lanceolate setae usually restricted to base
- Forewing buds with many lanceolate setae distributed over the whole wing bud margin (figure 29) *T. schini* Brèthes
- Forewing buds with many lanceolate setae distributed over the whole wing bud margin (figure 29) *T. sordida* Burckhardt
- 6 Antennae 7-segmented. Forewing buds large, with humeral lobes. Thoracic tergites large. Caudal plate bearing a short process apically (figure 30). *T. venata* sp. n.
- Antennae 8-segmented. Forewing buds small, without humeral lobes. Pteronotum with small sclerites. Caudal plate angular apically (figure 27). 7
- 7 Head, thorax and wing buds without lanceolate setae dorsally (figure 27).
- Head, thorax and wing buds with conspicuous lanceolate setae dorsally (figure 28) *T. acuticauda* Burckhardt and Lauterer
- Head, thorax and wing buds with conspicuous lanceolate setae dorsally (figure 28) *T. maculipectus* sp. n.

Leurolophus Tuthill

Leurolophus Tuthill, 1942: 92. Type species: *Leurolophus vittatus* Tuthill, by original designation and monotypy

When adding *L. inopinatus* to the previously monotypic genus *Leurolophus*, Burckhardt (1989) noted some important differences (head shape, presence of costal break and absence of cellular pattern on membrane in the forewing) to *L. vittatus*, the type species. Despite these differences, *L. inopinatus* was assigned to *Leurolophus* mostly on the basis of the paramere shape, and the egg which lacks an apical filament. Burckhardt and Lauterer (1989) recorded two specimens from Dominican amber which they referred to *Tainarys*. The present improved material base suggests that head and forewing structure in the adults, and the position of the anus in the larvae define *Leurolophus* and *Tainarys* (cf. keys). The paramere shape is only superficially similar, and presence or absence of an apical pedicel in eggs occur in other groups in closely related species (e.g. *Aphalara*, Burckhardt and Lauterer, 1997).

Here we transfer *L. inopinatus* to *Tainarys* (see below), and the fossil species from Dominican amber to *Leurolophus*. The latter resembles *L. vittatus* in the head shape, whereas the paramere is lamellar and the male proctiger indistinctly 2-segmented resembling *L. oriformae*. As *L. vittatus* and *L. oriformae*, the amber species lacks a costal break, bears a cellular pattern on the forewing membrane, and has stout legs.

***Leurolophus oriformae* sp. n.**

(figures 23A–H, 24)

Description. Adult. Coloration. Yellowish, median longitudinal stripe on vertex and pronotum dark brown. Antennae yellow with apices of segments 4, 6 and 8, and entire segments 9 and 10 dark brown to black. Compound eyes reddish to greyish. Meso and metanotum bearing longitudinal dark stripes separated by yellowish or white bands. Thorax laterally and ventrally dark brown to black with lighter

areas. Legs ochreous. Forewings dirty yellowish with brown dots and a narrow brown submarginal band, ends of veins along wing margin with dark dots, vein $M + Cu_1$ over more than half its length conspicuously black (figure 23A). Hindwings whitish. Abdomen including genitalia yellowish.

Structure. Head, in dorsal view, elongate (figure 23B), bearing flat lobes anteriorly, flattened above; in profile, cuneate, only weakly inclined from longitudinal body axis. Vertex rectangular, with angular lobes antero-exteriorly, surface rugous, sparsely covered in short setae. Median suture fully developed. Preocular sclerite developed, forming a pointed tubercle. Compound eyes adpressed, post-occipital sclerites large, extended laterally. Antennae 10-segmented, inserted on ventral face in front of compound eyes, bearing each a subapical rhinarium on segments 4, 6, 8 and 9; shorter terminal seta about as long as segment 10 and about half as long as longer seta. Frons narrow, longer than wide (figure 23C). Clypeus flat, heart-shaped. Thoracic dorsum flat with meso and metascutellum slightly raised. Pronotum transversely rectangular, mesopraescutum transverse, ribbon-like. Pronotum expanded laterally, propleurites displaced antero-ventrally. Tegulae flattened, parypterae much enlarged and plate-like. Legs stout, femora irregularly thickened, profemora with large hump in the middle of the inner face, mesofemora with similar hump but placed apically. Metacoxae with flattened tubercular meracanthus and large membranous cylindrical tubercle on the trochanteral cavity (figure 23H). Metatibia with 6–8 short, sclerotized spurs. Forewings (figure 23H) without costal break, membrane bearing irregular large tubercles. Genitalia as in figure 23D–G. Male proctiger irregularly 2-segmented. Male parameres lamellar, with a group of thick spines on the inner face in apical half. Distal portion of aedeagus straight with weakly expanded apex; sclerotized end tube of ductus ejaculatorius short. Female genitalia, in profile cuneate, dorsal margin of proctiger shallowly concave. Valvulae dorsalis elongately cuneate, weakly curved. Valvulae ventralis without ventral teeth.

Measurements in mm (1 ♂, 1 ♀). HW 0.43–0.48; AL 0.39–0.40; WL 1.15–1.40; MP 0.22; PL 0.16; AA 0.15; FP 0.44; AL/HW 0.83–0.91; WL/HW 2.67–2.92; WL/WW 2.25–2.33; TL/HW 0.56–0.63; MP/HW 0.51; FP/HW 0.92; FP/SL 1.26; FP/CL 2.44.

Fifth instar larva (figure 24). Brown, membranes yellowish orange. Body elongate. Antennae 8-segmented with one rhinarium on each of segments 3 and 5, and two on segment 7. Head, wing buds and caudal plate sparsely setose dorsally. Thoracic tergites small. Forewing buds moderately large, without humeral lobes, margins bearing normal setae which are slightly larger than those on the dorsal surface. Legs relatively large and slender with fused tibiotarsus, claws absent. Caudal plate angular, truncate apically, bearing a few marginal lanceolate setae. Anus terminal, circumanal ring consisting of several pore rows.

Host plants, gall and biology. *Lithrea molleoides*. The larvae develop on the leaves, together with those of *Calophya clavuligera*. Contrary to the latter, they do not appear to induce any deformations.

Distribution. Argentina (Misiones), Brazil (São Paulo) and Uruguay (Lavallejo).

Material examined. HOLOTYPE ♂, **Argentina**: Misiones Province, Rt. 14, 3 km E Centinela, 29.xi.1995, *Lithrea molleoides* (H. A. Cordo), dry mounted (NHMB).

PARATYPES. **Argentina**: 24 ♂, 26 ♀, ca 40 larvae, same data as holotype. **Brazil**: 2 ♂, 3 ♀, São Paulo, Gramadinko, 16.ii.1989, *Lithrea ?molleoides* (F. D. Bennet, D. H. Habeck and L. Crestana). **Uruguay**: Lavalleja, Cerro de Arequita, 4.x.1995 (A. Baz). Dry mounted and preserved in alcohol (BMNH, MHNG, NHMB, SABC, USNM).

Leurolophus vittatus Tuthill

(figure 23I)

Leurolophus vittatus Tuthill, 1942: 92. Holotype ♂, USA: Arizona, Tumacacari Mountains, 22.vii.1938 (R. H. Beamer) (SCUK)

Description. Adult. By Burckhardt and Lauterer (1989).

Fifth instar larva. By White and Hodkinson (1985).

Host plants, gall and biology. *Rhus choriophylla* Wootton and Standley, *R. virens* Lindh. (Anacardiaceae).

Distribution. USA (Arizona, Texas) (Tuthill, 1942; Burckhardt and Lauterer, 1989).

Material examined. USA: 3 ♂, 8 ♀, Arizona, Sycamore Canyon, 6.iv.1950, *Rhus choriophylla* Wootton and Standley (Kaiser and Crow) (MHNG, NHMB).

Tainarys Brèthes

Tainarys Brèthes, 1920: 133. Type species: *Tainarys schini* Brèthes, by monotypy

Tainarys is defined here by the anteriorly rounded head, the short, broad frons, the forewings with costal break and surface spinules on the wing membrane in adults and the ventral anus in the larvae. Following this definition, a fossil species from Dominican amber which was assigned to *Tainarys* by Burckhardt and Lauterer (1989) is transferred here to *Leurolophus*, and *Leurolophus inopinatus* to *Tainarys*, respectively. The assignment of the unnamed species from Brazil (Burckhardt and Lauterer, 1989) to *Tainarys* is confirmed here; it resembles most *T. inopinata*.

Tainarys acuticauda Burckhardt and Lauterer

(figure 27)

Tainarys acuticauda Burckhardt and Lauterer, 1989: 657. Holotype ♂, Chile: V Region, La Campana National Park, 1300 m, 11.i.1985, *Schinus* sp. (D. Hollis) (BMNH)

Description. Adult. By Burckhardt and Lauterer (1989).

Fifth instar larva (figure 27). Body yellowish to brownish, membranes light. Dorsal sclerites of head and thorax ochreous, wing buds light brown, abdominal dorsal sclerites and caudal plate brown. Antenna ochreous with apex dark brown to black. Body outline broadly oval. Antennae 8-segmented with one rhinarium on each of segments 3 and 5, and two on segment 7. Head and wing buds sparsely setose dorsally. Thoracic tergites small. Forewing buds moderately large, without humeral lobes. Margins of wing buds bearing lanceolate setae which are pointed or, more often truncate but slender apically. Legs relatively large and slender with fused tibiotarsus, claws absent. Caudal plate bluntly angular apically, bearing marginal and a few dorsal lanceolate setae similar to those of wing buds; dorsal lanceolate setae arranged in transverse and longitudinal rows. Anus ventral, circumanal ring small, consisting of one row of elongate pores.

Host plants, gall and biology. *Schinus montanus* (Philippi) Engler and *S. patagonicus* (Philippi) Johnston; a series of adults was also collected on *S. polygamus* which may be accidental. Inducing irregular leaf roll galls.

Distribution. Chile (V, VII–IX Regions). Recorded from Chile (V and VIII Regions) (Burckhardt and Lauterer, 1989).

Material examined. Chile: V Region, adults, type series including holotype, Province Quillota, La Campana National Park, 1300 m, 11.i.1985, *Schinus* sp.

(D. Hollis); adults, same data but La Campana National Park, Sector Granizo, from leaf roll galls on *Schinus montanus* (F. Sáiz); 2 ♂, 2 larvae, same data but La Campana National Park, Sector Ocoa, 1995, *Schinus montanus*; VII Region, 1 ♂, 1 ♀, Province Talca, G. de Vilches Park, sector Piedras blancas, 1350–1600 m, 12.i.1996, *Schinus patagonicus* (D. Burckhardt); 23 ♂, 21 ♀, 2 larvae, same data but sector Majadilla, 1350–1550 m, 13.i.1996; 57 ♂, 53 ♀, 13 larvae, same data but El Enladrillado, Valle El Venado, 150–1700 m, 14.i.1996; VIII Region, 1 ♀, Province Ñuble, 10 km W Termas de Chillan, 1250 m, 12–13.xii.1990, *Nothofagus* forest (D. Agosti and D. Burckhardt); 1 ♂, 5 ♀, same data but 20 km on road Cabrero to Yungay, 300 m, 18.i.1996, *Schinus polygamus* (D. Burckhardt); IX Region, 2 ♂, 1 ♀, Province Malleco, Nahuelbuta National Park, 1300 m, 16–17.xii.1990, *Nothofagus antarctica* forest, *Schinus patagonicus* var. *crenuloides* (D. Agosti and D. Burckhardt); 2 ♂, 9 ♀, 1 larva, same data but Tolhuaca National Park, sector Laguna Verde, 1000–1300 m, 27.i.1996, *Schinus patagonicus* (D. Burckhardt); 5 ♂, 1 ♀, same data but Province Cautín, Conguillío National Park, 950 m, 19–21.xii.1990, mixed *Nothofagus* forest, *Schinus patagonicus* var. *crenuloides* (D. Agosti and D. Burckhardt); 2 ♂, 1 larva, same data but 1150 m, 19–20.xii.1990, *Nothofagus antarctica* forest; 3 ♂, 1 larval skin, same data but 1100 m, 30.i.1996, *Schinus patagonicus* (D. Burckhardt). Dry and slide mounted, and stored in alcohol (MHNG, NHMB, UCVA).

***Tainarys inopinata* (Burckhardt), comb. n.**

(figure 63)

Leurolophus inopinatus Burckhardt, 1989: 872. Holotype ♂, Paraguay: Province Presidente Hayes, Trans-Chaco 293 km, Estancia Apendice, 1.xi.1988, at light (F. Baud) (MHNG)

Description. Adult (figure 63). By Burckhardt (1989).

Larva, host plants, gall and biology unknown.

Material examined. **Paraguay:** HOLOTYPE ♂, 14 ♂, 29 ♀ PARATYPES; Province Presidente Hayes, Trans-Chaco 293 km, Estancia Apendice, 1.xi.1988, at light (F. Baud). Dry mounted (MHNG, NHMB).

Comments. *Tainarys inopinata* bears an anteriorly rounded head, a short, wide frons, forewings with a costal break and small surface spinules on the membrane, and relatively slender legs. Because of these characters *T. inopinata* belongs to *Tainarys* rather than to *Leurolophus* as was suggested by Burckhardt (1989).



FIGS 63, 64. *Tainarys* spp.: (63) SEM picture of adult *T. inopinata*; (64) deformations (arrow) of *T. sordida* on *Schinus montanus*.

***Tainarys maculipectus* sp. n.**
(figures 25A–E, 28)

Description. Adult. Coloration. Head whitish to yellowish with reddish to brownish small dots. Thoracic dorsum black with some white lateral dots and reddish platellae, in younger specimens with brown spots and more expanded red colour. Antennae yellow, segments 9 and 10 black, apices of segments 4 and 6 brown. Clypeus black. Thorax laterally and ventrally black with ochreous patches and white and red dots. Legs yellow, pro and mesocoxae blackish. Forewings yellow base whitish, a single brown spot at the apex of vein Cu_{1b} . Hindwings whitish. Abdomen including genitalia yellow.

Structure. Head about as wide as thorax, in profile, inclined in a 45° angle to longitudinal body axis. Vertex flat anteriorly smoothly passing into genae, median suture fully developed. Compound eyes hemispherical. Antennae 10-segmented with each a subapical rhinarium on segments 4, 6, 8 and 9 shorter terminal seta about as long as segment 10, longer seta about 1.5 times as long. Frons short wider than long. Clypeus pear-shaped. Pronotum transverse, short, very slightly curved backwards at the sides; propleurites partially hidden by eyes, rectangular, both dorsal branches of suture developed, epimeron larger than episternum. Mesopraescutum short, transverse, mesoscutum flat; meso and metascutellum forming distinctly raised tubercles. Legs relatively slender, pro and mesofemora slightly thickened. Metacoxae bearing a flat, tubercular meracanthus and a conical membraneous process on the trochanteral cavity. Forewings (figure 25A) subrhomboidal, vein C + Sc straight or weakly concave, slightly widened, costal break developed, membrane transversely rugose, semi-transparent. Genitalia as in figure 25B–E.

Measurements in mm (1 ♂, 1 ♀). HW 0.47–0.59; AL 0.48–0.53; WL 0.88–1.33; MP 0.21; PL 0.12; AA 0.12; FP 0.43–0.51; AL/HW 0.83–1.02; WL/HW 1.87–2.25; WL/WW 2.05–2.13; TL/HW 0.56–0.60; MP/HW 0.45; FP/HW 0.73–0.96; FP/SL 1.19–1.50; FP/CL 3.31–5.10.

Fifth instar larva (figure 28). Body brown, membranes light. Dorsal sclerites of head and thorax light brown; wing buds, abdominal dorsal sclerites and caudal plate dark brown. Antenna ochreous with apex dark brown to black. Body outline broadly oval. Antennae 8-segmented with one rhinarium on each of segments 3 and 5, and two on segment 7. Thoracic tergites small. Forewing buds moderately large, without humeral lobes. Truncate lanceolate setae present on head and thorax dorsally, and on wing buds and abdomen dorsally and laterally; lanceolate setae denser and coarser than in *T. acuticauda*. Legs relatively large and slender with fused tibiotarsus, claws absent. Caudal plate pointedly angular apically; dorsal lanceolate setae arranged in transverse rows. Anus ventral, circumanal ring small, consisting of one row of pores which are elongate.

Host plants, gall and biology. *Schinus polygamus* (Cav.) Cabrera. Inducing irregular leaf roll galls.

Distribution. Argentina (Mendoza), Chile (Regions IV, V and Metropolitana).

Material examined. HOLOTYPE ♂, **Chile:** V Region, Province San Felipe, El Tártaro, 25 km N San Felipe, 32°37'S 70°42'W, 1000 m, 26.xii.1993, *Schinus polygamus* (D. Burckhardt), dry mounted (MHNG).

PARATYPES. **Argentina:** 1 ♂, 2 ♀, Mendoza Province, Mendoza Valley, Uspallata, 1900 m, 30.xii.1995, *Schinus polygamus* (D. Burckhardt); 2 ♂, 2 ♀, same data but Potrerillos, 1500 m, 31.xii.1995; 3 ♀, same data but, 1300 m, 17.i.1997; 1 ♀, same

data but Villa Hodel, 7 km Cacheuta to Mendoza, 1100 m, 17.i.1997; 1 ♂, 6 ♀, 1 larval skin, same data but 47 km Mendoza to Villa Vicencia, 1400 m, 18.i.1997; 1 ♂, 2 ♀, same data but above Villa Vicencia, 50 km NW Mendoza, 1800–2200 m. **Chile:** IV Region, 1 ♀, 1 larval skin, Province Elqui, 20 km S Vicuña to Hurtado, near Puente El Pangue, 1600 m, 18.xii.1995, *Schinus polygamus* (D. Burckhardt); 1 ♂, 1 ♀, same data but ca 50 km NE La Serena, Alentejo Latorre, 1000 m, 19.xii.1995; V Region, 1 ♂, 2 ♀, 3 larval skins, Province San Felipe, Putaendo, 8 km N San Felipe, 700 m, 12–13.i.1997, *Schinus polygamus* (D. Burckhardt); 2 ♂, 2 ♀, same data but El Asiento, 10 km NW San Felipe, 900 m, 13–20.i.1997; 1 ♂, 1 ♀, same data but Termas de Jahuel, 1000 m, 21.i.1997; 2 ♂, 1 ♀, 1 larva skin, same data as holotype; 2 ♀, same data but Putaendo Valley, 1100 m, 24.xii.1995; 1 ♀, Province Los Andes, 25 km W Portillo, 32°50'S 70°08'W, 1900–2100 m, 1.xii.1993, *Schinus polygamus* (D. Burckhardt); 1 ♂, same data but Guardia Vieja, near Portillo Ski Centre, 21.x.1995 (R. Muñoz); 1 ♀, Province Quillota, La Campana National Park, Sector Ocoa, 400–500 m, from leaf roll galls of *Schinus polygamus* (F. Sáiz) (UCVA); Regions V and Metropolitana: 6 ♂, 6 ♀, Provinces Quillota and Tiltil, Cuesta la Dormida, 10 km W Tiltil, 33°04'S 71°02'W, 1200 m, 15.xi.1992, *Schinus polygamus* (D. Burckhardt); 3 ♂, same data but 7–10 km W Tiltil, 950–1200 m, 28.xii.1993. Dry and slide mounted and preserved in alcohol (BMNH, MHNG, NHMB, USNM).

Tainarys schini Brèthes

Tainarys schini Brèthes, 1920: 133. Lectotype ♂, Argentina: Buenos Aires, 10.xi.1919, Molle de Incienso (= ?*Schinus fasciculatus*) (J. Brèthes) (MACN), designated by Burckhardt, 1987a

Description of adult and larva by Lizer (1943), White and Hodkinson (1985) and Burckhardt (1987a).

Host plants, gall and biology. *Schinus fasciculatus* (Grieseb.) Johnston (reported as Molle de Incienso, *Schinus dependens* or *Schinus polygamus*). Producing barrel-shaped leaf margin rolls (Brèthes, 1920; Houard, 1933; Lizer, 1943; Lizer and Molle, 1945).

Distribution. Argentina (Buenos Aires), Uruguay (Montevideo, Rocha); previously reported by Brèthes (1920), Lizer (1943), Hodkinson and White (1981), Burckhardt (1987a) and Burckhardt and Lauterer (1989).

Material examined. **Argentina:** 3 larvae, Vicente Lopez. **Uruguay:** 1 adult, 9 larvae, Montevideo, 29.vi.1943, *Schinus* sp. (H. L. Parker and A. Silveira); 1 ♀, Rocha, Chuy, Fuerte de San Miguel, 12.x.1995 (A. Baz). Dry and slide mounted (NHMB).

Tainarys sordida Burckhardt

(figures 29, 64)

Tainarys sordida Burckhardt, 1987a: 314. Holotype ♂, Argentina: Río Negro, El Bolsón, Mount Piltriquitron, 580 m, 22.iv.1961, beaten from *Colletia*, *Fabiana imbricata*, *Aristotelia maqui*, *Maytenus boaria*, *Berberis buxifolia*, *Baccharis magellanica* and *Lomatia obliqua*, nr. 410 (G. Topal) (HNHM), probably destroyed.

Description. Adult. By Burckhardt (1987a).

Fifth instar larva (figure 29). Sclerites yellowish to ochreous, membranes whitish yellow. Body broadly oval. Antennae 7-segmented, with 1 rhinarium on each of

segments 3 and 5 and 2 rhinaria on segment 7. Thoracic tergites small. Head, thorax, wing buds and caudal plate sparsely covered in dorsal setae. Head with a few thick or lanceolate setae anteriorly. Forewing buds moderately large, without humeral lobes. Wing buds with sparsely spaced marginal lanceolate setae, pointed or narrowly truncate apically. Legs relatively stout, with fused tibio-tarsus, claws absent. Caudal plate rounded apically, bearing a few marginal lanceolate setae similar to those of wing buds; dorsal surface granular. Anus ventral; circumanal ring small, consisting of a single row of elongate pores.

Host plants, gall and biology. *Schinus fasciculatus* (Grieseb.) Johnston, *S. latifolius* (Gillies) Engler, *S. montanus* (Philippi) Engler, *S. patagonicus* (Philippi) Johnston, *S. polygamus* (Cav.) Cabrera, *S. velutinus* (Turez.) Johnston. Forming irregular leaf roll galls or crumpling of young leaves (figure 64). Flores *et al.* (1989) found two generations per year in a population on *Schinus polygamus* in the Santiago area. The emergence of adults coincided with the growth of new twigs.

Distribution. Argentina (Cordoba, Mendoza, Río Negro) and Chile (Regions III–IX and Metropolitana). Recorded from Argentina (Cordoba, Río Negro) and Chile (Regions V, VII and Metropolitana) (Burckhardt, 1987a; Flores *et al.*, 1989; Flores, 1990; Sáiz and Nuñez, 1997).

Material examined. **Argentina:** Mendoza, 3 ♂, 4 ♀, Mendoza Valley, Uspallata to Potrerillos, 1700 m, 30–31.xii.1995, *Schinus fasciculatus* (D. Burckhardt); 2 ♂, 2 ♀, same data but Potrerillos, 1500 m, 31.xii.1995; 1 ♂, 1 ♀, same data but 12 km on road Las Cuevas to Puente del Inca, 2800 m, 16.i.1997, without host information; 1 ♂, same data but Punta de Vacas to Uspallata, 1900 m, 16–19.i.1997, *Schinus fasciculatus*; 69 ♂, 40 ♀, 2 larval skins, same data but Potrerillos, 1300 m, 17.i.1997; 20 ♂, 44 ♀, 20 larvae and larval skins, same data but Villa Hodel, 7 km on road Cacheuta to Mendoza, 1100 m, 17.i.1997; 34 ♂, 18 ♀, 2 larval skins, same data but 47 km on road Mendoza to Villa Vicencia, 1400 m, 18.i.1997; 26 ♂, 25 ♀, 1 larval skin, same data but above Villa Vicencia, 50 km NW Mendoza, 1800–2200 m; 10 ♂, 7 ♀, 1 larval skin, same data but Mendoza Valley, 27 km Uspallata to Potrerillos, 1500 m, 19.i.1997; 3 ♂, 1 ♀, Mendoza, Zoological Garden, vii.1997 (S. Roig); Río Negro, 7 ♂, 7 ♀, El Bolsón, 22.iv.1961 (G. Topál). **Chile:** III Region, 1 ♀, Province Huasco, Huasco, 28°27'S 71°05'W, 50 m, 13.xii.1993, *Schinus polygamus* (D. Burckhardt); 8 ♂, 3 ♀, 1 larval skin, same data but 85 km S Vallenar, 29°02'S 70°52'W, 1000 m, 13.xii.1993; IV Region, 32 adults, Province Elqui, 15 km SW Viñita Baja, 29°50'S 70°50'W, 450 m, 4.xii.1993, *Schinus polygamus* (D. Burckhardt); 1 ♂, 3 ♀, 1 larval skin, same data but Viñita Baja to Condoriaco, 29°45'S 70°50'W, 1000–1400 m, 4.xii.1993; 12 adults, 2 larval skins, same data but Condoriaco to Alente Latorre, 29°40'S 70°53'W, 1200 m, 4.xii.1993; 18 adults, same data but 15–25 km S Vicuña, 30°15'S 70°40'W, 1300–1700 m, 14.xii.1993; many adults and crumpled leaves, same data but 10 km S Vicuña to Hurtado, 900 m, 18.xii.1995; many adults and crumpled leaves, same data but 20 km S Vicuña to Hurtado, near Puente El Pangué, 1600 m, 18.xii.1995; several adults and larval skins, same data but ca 40 km SW Viñita Baja, 450 m, 19.xii.1995; 12 adults, same data but ca 45 km ENE La Serena, Viñita Baja to Condoriaco, 800–1000 m, 19.xii.1995; 16 adults, same data but ca 50 km NE La Serena, Alente Latorre, 1000 m, 19.xii.1995; many adults and larvae, same data but Valle Elqui near Rivadavia, 750 m, 20.xii.1995; 10 adults, 1 larval skin, same data but Valle del Río Claro, Alcohuaz, 1700 m, 20.xii.1995; 9 ♂, 12 ♀, Province Limarí, Fray Jorge National Park, 250 m, 7–9.xii.1990, mediterranean scrub, *Schinus polygamus* (D. Agosti and D. Burckhardt); 11 adults and larvae,

same data but foot of hill, 18.ii.1985, *Schinus* sp. (D. Hollis); 16 adults, same data but Pedregal, 60 km SE Ovalle, 30°51'S 70°42'W, 800 m, 17.xii.1992, *Schinus polygamus* (D. Burckhardt); 1 ♂, 1 ♀, Province Choapa, Los Vilos, 6.v.1994, *Schinus latifolius* (T. Olivares); V Region, 20 adults, Province Petorca, El Guayacan, 20 km E Cabildo, 800 m, 17.v.1993, *Schinus polygamus* (D. Burckhardt); 2 ♂, 1 ♀, same data but Cuesta El Melón, 400 m, 22.xii.1995, *Schinus velutinus*; 32 adults, 3 larvae, Province San Felipe, Los Patos, 35 km N San Felipe, 17.v.1993, *Schinus polygamus* (D. Burckhardt); many adults and larvae, same data but El Tártaro, 25 km N San Felipe, 32°37'S 70°42'W, 1000 m, 26.xii.1993; 2 ♂, 4 ♀, same data but 5 km N El Tártaro, 30 km N San Felipe, 32°30' S 70°42'W, 1100 m, 26.xii.1993; many adults and larvae, same data but El Tártaro, 20 km N San Felipe, Putaendo Valley, 1100 m, 24.xii.1995; several adults and larval skins, same data but Termas de Jahuel, 1000 m, 21.i.1997; many adults and larvae, same data but Putaendo, 8 km N San Felipe, 700 m, 12–13.i.1997; many adults and larvae, same data but El Asiento, 10 km NW San Felipe, 900 m, 13–20.i.1997; 3 ♀, same data but Resguardo de los Patos, Putaendo, 1000 m, 4–5.x.1993, without host information (L. E. Peña); 1 ♀, Province Los Andes, near Portillo Ski Centre, Guardia vieja, 21.x.1995, on the leaves of *Schinus polygamus* (R. Muñoz G.); 27 adults, 25 km W Portillo, 32°50'S 70°08'W, 1900–2100 m, 1.xii.1993, *Schinus montanus* and *S. polygamus* (D. Burckhardt); 1 ♂, same data but 1800 m, subalpine scrub, 31.xii.1993, *Schinus montanus*; many adults, same data but 14 km Portillo to Río Blanco, Aconcagua Valley, 1500 m, 23.xii.1995, *Schinus montanus* and *S. polygamus*; several adults, same data but 19 km, 1900 m, *Schinus montanus*; many adults and larvae on crumpled leaves, same data but 28 km, 1500 m, *Schinus polygamus*; 5 ♂, 3 ♀, same data but Río Blanco, 1400 m, *Schinus montanus*; many adults, same data but Portillo to Río Blanco, Aconcagua Valley, 1800 m, 31.xii.1995; 8 adults, Province Quillota, El Bocco, 5.v.1993, *Schinus velutinus* (D. Burckhardt); 2 larvae, same data but Cuesta La Dormnida, 10 km W Tilttil, 33°04'S 71°02'W, 1200 m, 15.xi.1992; *Schinus polygamus*; 16 adults, same data but Quillota, 32°52'S 71°13'W, 200 m, 1.i.1994; *Acacia caven* steppe, *Schinus latifolius* and *S. velutinus*; many adults and larvae, same data but Quillota, La Palma, 300 m, 25.xii.1995; several adults and larvae, same data but 15.i.1996; 7 adults, same data but La Campana National Park, 500 m, 11.i.1985, *Schinus* sp. (D. Hollis); 1 ♂, 3 ♀, same data but La Campana National Park, Sector Ocoa, 400–500 m, from leaf galls of *Schinus polygamus* (F. Sáiz); 1 ♀, same data but from conical leaf gall on *Schinus polygamus*; 1 ♂, 6 ♀, 12 larvae, same data but from leaf roll gall on *Schinus polygamus*; 4 ♂, 3 ♀, same data but from leaves of *Schinus latifolius*; 4 ♂, 2 ♀, Province Valparaiso, La Retuca, 33°08'S 71°20'W, 300 m, 20.xi.1992, *Schinus latifolius* (D. Burckhardt); 14 adults, same data but Fundo El Pequén, Valle Marga Marga, 33°06'S 71°23'W, 200 m, 21.xi.1992; Region Metropolitana, 2 ♂, 1 ♀, on road Corral Quemado and Farellones, 1700 m, 19.v.1993, *Schinus montanus* (D. Burckhardt); 20 adults, 29–41 km Santiago La Disputada Road, 9.1.1985, *Schinus* sp. (D. Hollis); 18 adults, same data but Maipo Valley, El Volcan, 10.i.1985; many adults, Cuesta La Dormida, 7–10 km W Tilttil, 33°04'S 71°02'W, 950–1200 m, 28.xii.1993, *Schinus latifolius* and *S. polygamus* (D. Burckhardt); VI Region, many adults, Province Colchagua, La Rufina, Río Tinguiririca, 650 m, 11.i.1996, *Schinus polygamus* (D. Burckhardt); several adults and larvae, same data but Bella Vista, Río Claro, 900 m, 11.i.1996; VII Region, 2 ♂, Province Talca, Armerillo to Las Garzas, Maule Valley, 60–80 km E Talca, 35°45'S 71°00'W, 700 m, 25.xi.1992, *Schinus polygamus* (D. Burckhardt); 1 ♀, same data but Gil de Vilches Park, section Piedras Blancas, 1350–1600 m,

12.i.1996; *Schinus patagonicus*; 3 ♂, same data but section Majadilla, 1350–1550 m, 13.i.1996; many adults and larval skins, same data but Gil de Vilches Park, El Enladrillo, Valle El Venado, 1350–1700 m, 14.i.1996; 1 ♂, 1 ♀, crumpled leaves, Province Cauquenes, 10 km W Cauquenes, 400 m, 12.ii.1996, *Schinus polygamus* (D. Burckhardt); several adults and larvae, same data but E Cauquenes, 400 m, 12.ii.1996; 1 ♂, 1 ♀, same data but Cauquenes, 6.vi.1898, from trees (collector not mentioned); VIII Region, 10 adults, 6 larvae, crumpled leaves, Province Ñuble, near Recinto, ca 60 km E Chillan, 400–600 m, 12.xii.1990, Valdivian forest, *Schinus polygamus* (D. Agosti and D. Burckhardt); 10 adults, same data but 20 km W Termas de Chillan, 16.i.1985, *Schinus* sp. (D. Hollis); several adults, same data but 10 km on road Cabrero to Yungay, near province border, 200 m, 18.i.1996, *Schinus polygamus* (D. Burckhardt); several adults, 1 larval skin, same data but 20 km on road Cabrero to Yungay, 300 m; 5 ♂, 1 ♀, same data but Province Concepción, Escuadron, 20 km S Concepción, 20 m, 17.i.1996; 9 adults, Prov. Biobío, Lago Laja National Park, 19.i.19985, *Schinus* sp. (D. Hollis); 2 ♂, 1 ♀, same data but Laguna del Laja National Park, sector Chacay, 1200 m, 19.i.1996, *Schinus polygamus* (D. Burckhardt); many adults, larvae and larval skins, same data but sector Lagunillas, 1100 m, 21.i.1996; 2 ♂, 2 ♀, same data but sector Saltos Chilcas and Torbelino, 1100 m, 21.i.1996; several adults, same data but Laguna del Laja National Park to El Abanico, 900–1100 m, 22.i.1996; 3 ♂, 2 ♀, same data but 10 km W Antuco, 500 m, 23.i.1996; IX Region, several adults, larvae and crumpled leaves, Province Cautín, Conguillío National Park, 950 m, 19–21.xii.1990, mixed *Nothofagus* forest, *Schinus patagonicus* var. *crenuloides* (D. Agosti, and D. Burckhardt); 3 ♂, 2 ♀, same data but Playa Linda, 19–20.xii.1990, *Nothofagus antarctica* forest, *Schinus patagonicus* (D. Burckhardt). Dry and slide mounted, and preserved in alcohol (BMNH, IAIM, MHNG, NHMB, UCVA).

Comments. The holotype of *T. sordida* and other material collected by G. Topal in Argentina which was studied by Burckhardt (1987a, 1987b, 1988) could not be traced at the HNHM (T. Vasarhelyi, pers. commun.). It seems that the material was destroyed during the shipment from Liverpool to Budapest in 1985.

***Tainarys venata* sp. n.**

(figures 25F–J, 26, 30)

Description. Adult. Coloration. Orange brown with dark brown pattern which is more or less extensive depending on age. Dorsally usually darker than laterally. Head and thoracic dorsum with a few white dots. Antennae whitish with ultimate 2–3 segments dark brown. Lower head surface light with dark clypeus. Legs brownish with yellowish tibiae. Forewings with greyish brown pattern consisting of dense spots and patches, remainder light, whitish or yellowish, forming whitish semi-circles along wing margin. Hindwings whitish. Abdomen dark brown with ochreous intersegmental membranes.

Structure. Head (figure 25F) about as wide as thorax, inclined in a 45° angle to body axis. Vertex slightly raised around posterior ocelli and antero-exteriorly, passing smoothly into genae anteriorly, surface finely rugous and sparsely covered in small setae. Antenna 10-segmented with each a subapical rhinarium on segments 4, 6, 8 and 9; shorter terminal seta slightly shorter, longer seta longer than segment 10. Frons (figure 25G) short, broader than long. Pronotum shortly rectangular, suture with both dorsal branches developed; epimeron much larger than episternum.

Mesopraescutum short, mesonotum bulged, meso and metascutellum forming raised tubercles. Legs relatively slender, femora thickened. Metacoxae with very small, tubercular meracanthus and small membranous tubular tubercle at trochanteral cavity. Metatibia with a crown of 6–8 black, strongly sclerotized black spurs, metabasitarsus with two black spurs. Forewing (figure 25I) oval with cross-veins between R_s/M_{1+2} and M_{3+4}/Cu_{1a} ; $C + Sc$ straight, costal break developed. Genitalia as in figure 26. Male proctiger indistinctly 2-segmented, subgenital plate elongate. Parameres lamellar with a row of strongly sclerotized pegs on the inner face. Distal portion of aedeagus straight, weakly widened apically. Female terminalia shortly cuneate, dorsal margin of proctiger almost straight, weakly setose. Subgenital plate truncate apically, bearing a few rows of dense long setae with capitate apex; the setae form together a rigid structure, the rigidity being enhanced by a wax cover. Valvulae dorsalis triangular and sclerotized above, membranous below.

Measurements in mm (1 ♂, 1 ♀). HW 0.51–0.57; AL 0.31–0.34; WL 1.05–1.35; MP 0.20; PL 0.15; AA 0.19; FP 0.31; AL/HW 0.61; WL/HW 2.06–2.37; WL/WW 1.84–2.01; TL/HW 0.51–0.59; MP/HW 0.29; FP/HW 0.54; FP/SL 0.94; FP/CL 2.38.

Fifth instar larva (figure 30). Black. Body heart-shaped, dorsal surface sparsely covered in small setae. Thoracic tergites large, quadrate. Antennae 7-segmented with each 1 rhinarium on segments 3 and 5, and 2 rhinaria on segment 7. Head truncate anteriorly. Wing buds large, forewing buds with relatively large humeral lobes. Head laterally, wing buds and abdomen with densely spaced marginal funnel-shaped setae. Legs relatively slender, with fused tibio-tarsus, claws absent. Caudal plate ending in a small process apically. Anus ventral; circumanal ring small, circular, consisting of a single row of elongate pores.

Egg. Short, oval without apical filament (figure 25H).

Host plants, gall and biology. *Schinus fasciculatus* (Grieseb.) Johnston, *Schinus polygamus* (Cav.) Cabrera. No deformations were observed on the leaves, but the material at hand is too scarce for definite conclusions.

Distribution. Argentina (Mendoza), Chile (IV Region).

Material examined. HOLOTYPE ♂, **Argentina**: Province Mendoza, Mendoza Valley, 1700 m, Uspallata Potrerillos, 30–31.xii.1995, *Schinus fasciculatus* (D. Burckhardt) (MHNG).

PARATYPES. **Argentina**: 2 ♂, 1 ♀, same data as holotype; 1 ♂, 2 ♀, same data but Punta de Vacas, Uspallata, 1900 m, 16–19.i.1997; 1 ♀, 1 larval skin; same data but 18 km Mendoza, Villa Vicencia, 700 m, 18.i.1997; 1 ♂, 1 ♀, Mendoza, Zoological Garden, vii.1997 (S. Roig); 33 ♂, 19 ♀, 4 adults without abdomen, Mendoza, Luján de Cuyo, 33°03'S 68°52'W, 28.xii.1994 (G. Debandi); 3 ♀, Mendoza, Santa Rosa, Ñacuán, 34°03'S 67°58'W, 21. i.1996, *Larrea cuneifolia* (G. Debandi). **Chile**: 1 ♂, 5 larvae and larval skins, IV Region, Province Elqui, Valle Elqui near Rivadavia, 750 m, 20.xii.1995, *Schinus polygamus* (D. Burckhardt). Dry and slide mounted (IAIM, MHNG, NHMB).

Tainarys spp.

In the following galls or larvae of unidentified *Tainarys* spp. are listed which were found on herbarium specimens deposited in the BMNH and CJBG.

Schinus bumelioides Johnston: irregular crumpling of leaves and larval skins, **Argentina**: Salta, Metán, Río Juramento, 26.4 km E 'Cabra Corral', 800 m, 24.x.1986 (L. Novara) (CJBG). *Schinus longifolius* (Lindl.) Speg.: irregular crumpling of

leaves, **Argentina**: Corrientes, Paso Troncón, 26.iii.1948 (Palacios-Cuezzo) (CJBG); irregular crumpling of leaves, **Paraguay**: Amambay, Pedro Juan Caballero, 740, 350 m, 26.iii.1951 (G. J. Schwarz) (CJBG). *Schinus meyeri* Barkley: leaf roll galls, **Argentina**: Salta, Santa Victoria Los Toldos, 1700–1900 m, 2.xi.1989 (L. J. Novara) (CJBG).

Phylogenetic relationships of *Calophya*

Calophya, *Microceropsylla* and *Pematobrachia*

Neither Enderlein (1921), Boselli (1930) nor subsequent authors provided characters which clearly define *Pematobrachia* and *Microceropsylla*, and differentiate them from *Calophya*. Brown and Hodkinson (1988) doubted that the first two genera are distinct from the last. To address this question two cladistic analyses were performed. In the first, adult characters were included for all previously and herein described species, with the exception of *C. clavuligera* and *C. pallidula* (tables 4, 5; figure 31). Some species were not available for examination and the characters were taken from the literature. The second analysis (tables 6, 7; figure 32) included a reduced number of species but with adult and larval characters. Again, for species with no material at hand, literature data were used.

The first analysis (tables 4, 5; figure 31) yielded after six runs 1637 (overflow) most parsimonious trees (length = 131, consistency index (CI) = 0.61, retention index (RI) = 0.96). Figure 31 shows a consensus (nelsen) tree in which neither *Calophya* auct., *Pematobrachia* nor *Microceropsylla* are monophyletic. The *Schinus* feeders are in two unrelated monophyletic groups.

The second analysis (tables 6, 7; figure 32) resulted after five runs in 48 most parsimonious trees (length = 242, CI = 0.61, RI = 0.86). The (nelsen) consensus tree (figure 32) confirms some of the results of the first analysis but is less conclusive due to the small number of included taxa. Here *Pematobrachia* + *Microceropsylla* are monophyletic but *Calophya* auct. remains paraphyletic. In contrast to the first analysis, in the second the *Schinus* feeders are monophyletic except for *C. duvauae* which groups with *C. rhois*.

Table 4. Adult characters of all *Calophya*, *Pematobrachia* and *Microceropsylla* spp. (except for *C. clavuligera* and *C. pallidula*) (cf. table 5, figure 31).

-
- 1 Body coloration uniform or multicoloured (0), strongly contrasting black head and thorax and yellow abdomen (1).
 - 2 Genal processes short, massive (0), long, conical (1), long, slender (2).
 - 3 Antenna 10-segmented (0), 7–9-segmented (1).
 - 4 Pterostigma of forewing petiolate (0), sessile (1), Rs branching off pterostigma (2).
 - 5 Hindwing with distinct M + Cu₁ (0), without (1).
 - 6 Paramere lamellar, subacute apically, with 1 inner apical sclerotized tooth (0), lamellar, truncate apically, with 2 inner apical sclerotized teeth (1), lamellar or triangular, with broad base, subacute apically, with 1 inner apical sclerotized tooth, inner face with several teeth in basal half (2), digitiform, with slightly expanded apex, with 2 inner apical sclerotized teeth (3), broadly lamellar, with 2 long apical sclerotized processes (4), subacute apically, with 1 inner apical sclerotized tooth, with process along posterior margin (5), shortly lamellar to narrowly triangular, with 2 large inner apical sclerotized teeth (6).
 - 7 Distal portion of aedeagus slender, club-shaped (0), short, inflated (1), long, inflated (2), strongly expanded apically (3).
 - 8 Female genitalia cuneate (0), long, with apical process (1), short, apically truncate (2), proctiger with apical hook (3).
-

Table 5. Matrix for adult characters (table 4, figure 31).

<i>schimae</i>	02001?00	<i>monticola</i>	01010612
<i>acutipennis</i>	0100?612	<i>nigra</i>	01001220
<i>andina</i>	02001101	<i>nigrella</i>	0100?6?0
<i>angulipennis</i>	01001610	<i>nigrilineata</i>	01000612
<i>arcuata</i>	0100???0	<i>nigridorsalis</i>	01000010
<i>aurea</i>	0100?6?0	<i>nigriconis</i>	02000612
<i>brevicornis</i>	00100312	<i>nigripennis</i>	010016?0
<i>buchananiae</i>	0102?312	<i>orbicola</i>	02001101
<i>californica</i>	0100?6?0	<i>oweni</i>	1000?6?0
<i>catillicola</i>	12001610	<i>patagonica</i>	02001101
<i>clausa</i>	02001101	<i>phellodendri</i>	01001220
<i>dicksoni</i>	01?0?6?0	<i>rahae</i>	00000010
<i>dubia</i>	0100?6?0	<i>rhicola</i>	00000010
<i>duvauae</i>	00001101	<i>rhois</i>	00000010
<i>evodiae</i>	01001220	<i>rotundipennis</i>	?110?61?
<i>flavida</i>	010016?0	<i>rubra</i>	02001101
<i>floricola</i>	02001101	<i>schimi</i>	02001101
<i>fusca</i>	01110610	<i>scrobicola</i>	02001101
<i>gallifex</i>	02001101	<i>shinjii</i>	01001220
<i>hermicitae</i>	12001610	<i>spondiasae</i>	00121503
<i>hyalina</i>	01010612	<i>stigmotacta</i>	01010612
<i>longispiculata</i>	00000430	<i>terebinthifolii</i>	12001610
<i>luzonensis</i>	1110?012	<i>triangula</i>	0000002?
<i>maculata</i>	01110312	<i>triozomima</i>	00001601
<i>mammifex</i>	02001101	<i>venusta</i>	0000?610
<i>mangiferae</i>	00100312	<i>verrucosa</i>	00001530
<i>meliorata</i>	01001400	<i>verticis</i>	0000???0
<i>minuta</i>	1100?6?0	<i>verticornis</i>	00000010
<i>miramarensis</i>	01010011	<i>washingtonia</i>	?100162?

The two analyses confirm Brown and Hodkinson's (1988) suggestion that *Pelmatobrachia* and *Microceropsylla* are not distinct from *Calophya*. Consequently, the three genera are synonymized here.

The Calophya spp. associated with Schinus

In neither of the two analyses discussed above are all *Schinus* feeders contained in a single monophyletic group. The second analysis is biased towards the *Schinus* feeders and larval characters. For this reason we think that the first analysis is a better estimate of the phylogenetic relationships within *Calophya* and use it here. Accordingly the *Schinus* feeding species are assigned to two groups, the *C. rubra* and *C. hermicitae* groups, respectively.

The *C. rubra* group, which is defined by the long apical processes on the female genitalia, and the multicoloured adults, contains 11 species. With the exception of *C. floricola*, which is known only from adults, the group was cladistically analysed (tables 8, 9; figure 33). Two runs yielded a single most parsimonious tree (length = 156, CI = 0.79, RI = 0.87).

The *C. hermicitae* group differs from the *C. rubra* group in the shorter female genitalia, the black/yellow adult body coloration, and the larval antenna which is triangular or which bears a broad base from which a slender process arises in the middle. The group includes four species, of which *C. clavuligera* is known from the

Table 6. Adult and larval characters of selected *Calophya*, *Pelmatobrachia* and *Microceropsylla* spp. (cf. table 7, figure 32).

Larva	
1	Anterior margin of head weakly concavely rounded, not cleft in the middle (0), forming two shallow lobes (1), forming two large lobes (2).
2	Antenna without (0), with sectasetae (1).
3	Antenna straight or weakly curved (0), strongly curved downwards (1), irregularly triangular (2), S-shaped (3).
4	Leg with claws (0), without or with strongly reduced claws (1).
5	Anterior margin of humeral lobes ending at or proximal to the middle of eye margin (0), distal of anterior eye margin (1).
6	Abdominal dorsum without (0), with median horns (1).
7	Caudal plate ratio > 0.5 (0), < 0.5 (1).
8	Circumanal ring oval (0), round (1), absent (2), terminal, multicellular, broken (3).
9	Head margin without or with unspecialized setae only (0), with clavate setae (1), with sectasetae (2).
10	Wing bud margin with unspecialized setae only (0), with clavate setae (1), with sectasetae (2).
11	Abdominal margin with sectasetae (0), without specialized setae (1), with lanceolate setae (2).
Adult	
12	Adult body coloration multicoloured or uniform (0), strongly contrasting black/yellow (1).
13	Genal processes short, massive (0), long, conical (1), long, slender (2).
14	Paramere lamellar, subacute apically, with 1 inner apical sclerotized tooth (0), lamellar, truncate apically, with 2 inner apical sclerotized teeth (1), lamellar or triangular, with broad base, subacute apically, with 1 inner apical sclerotized tooth, inner face with several teeth in basal half (2), digitiform, with slightly expanded apex, with 2 inner apical sclerotized teeth (3), broadly lamellar, with 2 long apical sclerotized processes (4), subacute apically, with 1 inner apical sclerotized tooth, with process along posterior margin (5), shortly lamellar to narrowly triangular, with 2 large inner apical sclerotized teeth (6).
15	Distal segment of aedeagus thick (0), slender with elongate apical dilatation (1), slender with globular apical dilatation (2).
16	Female genitalia cuneate (0), long, with apical process (1), short, apically truncate (2), proctiger with apical hook (3).

Table 7. Matrix for adult and larval characters (table 6, figure 32).

<i>schimae</i>	0000000000102?10	<i>nigridorsalis</i>	0000100000201000
<i>andina</i>	0000010100202121	<i>nigrilineata</i>	0020101000101602
<i>catillicola</i>	2121101022102600	<i>orbicola</i>	0010001211202111
<i>clausa</i>	0000010100202111	<i>patagonica</i>	0000000000202121
<i>duvauae</i>	000000?00100101	<i>rhois</i>	0000000000000000
<i>evodiae</i>	0000001000201200	<i>rubra</i>	0000010100202121
<i>gallifex</i>	1000001022002111	<i>schini</i>	2130101022002111
<i>hermitiae</i>	2121101022012600	<i>scrobicola</i>	2130010022002111
<i>longispiculata</i>	000000?100100400	<i>spondiasae</i>	000000?300100503
<i>mammifex</i>	0000010100202121	<i>terebinthifolii</i>	2120101022012600
<i>monticola</i>	1020100000201602	<i>verrucosa</i>	000000?300100500

Table 8. Adult and larval characters of the *Calophya rubra* group (excluding *C. floricola*) (cf. table 9, figure 33).

Larva	
1	Anterior margin of head weakly concavely rounded, not cleft in the middle (0), forming two shallow lobes (1), forming two large lobes (2).
2	Antenna without (0), with setasetae (1).
3	Antenna straight or weakly curved (0), strongly curved downwards (1), S-shaped (2).
4	Abdominal dorsum without (0), with median horns (1).
5	Caudal plate ratio > 0.5 (0), < 0.5 (1).
6	Circumanal ring oval (0), round (1), absent (2).
7	Head margin without or with unspecialized setae only (0), with clavate setae (1), with setasetae (2).
8	Wing bud margin with unspecialized setae only (0), with clavate setae (1), with setasetae (2).
9	Abdominal margin with setasetae (0), without specialized setae (1), with lanceolate setae (2).
Adult	
10	Genal processes short, broadly rounded (0), long, slender (1).
11	Forewing with (0), without surface spinules in addition to those in cell cu ₂ (1).
12	Forewings broadly rounded apically (0), narrowly rounded apically (1).
13	Distal segment of aedeagus thick (0), slender with elongate apical dilatation (1), slender with globular apical dilatation (2)

Table 9. Matrix for adult and larval characters of *Calophya rubra* group (table 8, figure 33); outgroup = *Calophya rhois*.

<i>rhois</i>	0000000000000	<i>orbicola</i>	0010121121101
<i>andina</i>	0001010021102	<i>patagonica</i>	0000000021012
<i>clausa</i>	0001010021111	<i>rubra</i>	0001010021112
<i>duvauae</i>	0000?0010000	<i>schini</i>	2120102201001
<i>gallifex</i>	1000102201101	<i>scrobicola</i>	2121002201101
<i>mammifex</i>	0001010021102		

larvae only and is associated with *Lithrea* spp. A cladistic analysis (tables 10, 11; figure 34) resulted in a single most parsimonious tree (length = 3, CI = 1.0, RI = 1.0).

Phylogenetic relationships within the Rhinocolinae

The Rhinocolinae were revised by Burckhardt and Lauterer (1989) who included 11 named genera and 31 named species. Park (1996) synonymized the monotypic Korean genera *Rhusaphalara* Park and Lee, 1982 and *Koreaphalara* Kwon, 1984 and their type species *R. minima* Park and Lee, 1982 and *K. koreana* Kwon, 1984, and transferred the taxon to the Rhinocolinae. *R. minima* develops on *Rhus chinensis* (Anacardiaceae), a host genus used also by other members of the subfamily (*Agonosцена crotalariae* (Petty) and *Leurolophus vittatus* Tuthill). Previously, Park and Lee (1982) had referred *Rhusaphalara* to the Aphalaridae and noted a

Table 10. Larval characters of the *Calophya hermiticae* group (cf. table 11, figure 34).

1	Claws distinct (0), indistinct (1).
2	Tibiotarsus relatively long and slender (0), short and stout (1).
3	Antenna relatively slender (0), compact (1).

Downloaded By: [Romanian Ministry Consortium] At: 10:24 20 May 2010

Table 11. Matrix for larval characters of *Calophya hermicitae* group (table 10, figure 34); outgroup = *Calophya rhois*.

<i>rhois</i>	000	<i>hermicitae</i>	111
<i>catillicola</i>	111	<i>terebinthifolii</i>	000
<i>clavuligera</i>	001		

resemblance to *Aphalara* and *Craspedolepta*, but they did not specify in what the resemblance consisted.

Here we transfer the genus *Notophyllura* from the Euphyllurinae to the Rhinocolinae (Hollis, pers. commun.). Hodkinson (1986) listed 11 characters for defining the Euphyllurinae but stated that the group is heterogeneous. Most of the characters he listed are connected with the compact body form (forewing shape, head shape, short antennae, stout legs); convergence is therefore likely. The presence of a well-defined preocular sclerite is not restricted to the Euphyllurinae but occurs also in other groups such as the Spondylaspidini, the Aphalarinae, the Diaphorininae and *Leurolophus*. *Notophyllura* shares the following additional characters with *Leurolophus*: antenna with four rhinaria, frons longer than wide, propleurites displaced antero-ventrally, forewing without costal break in the adults; and 8-segmented antennae with the rhinarium formula 3577, the fused tibiotarsus, the absence of claws, and the terminal anus in the last instar larva (unpublished BMNH data). These characters suggest that *Notophyllura* and *Leurolophus* are closely related. The larval tarsal arolium is small, trapezoidal and lacks a pedicel and a visible unguitactor, confirming the rhinocoline affinity.

Another taxon included here in the Rhinocolinae is an unnamed genus of at least five Pacific species (unpublished BMNH data) centred around '*Paurocephala longicella*' Tuthill, 1942. Heslop-Harrison (1952) referred it to *Parapaurocephala*, which Hodkinson (1983) regarded as a valid name. However, it is not available under provision of article 13 (a) of the International Code of Zoological Nomenclature (1985) due to the lack of a description. The metacoxae of the adults bear a short meracanthus but also a distinct membraneous tubercle at the trochanteral cavity. The antennae are 10-segmented with a single subapical rhinarium on each of segments 4–9. The male proctiger is unsegmented and bears a large posterior lobe. The last instar larvae have the tarsal segment and claws developed and bear a short trapezoidal tarsal arolium without pedicel and visible unguitactor. The antennae are 7-segmented with a rhinarium formula 345677. The body bears sectasetae and rod setae. The circumanal ring is ventral and v-shaped, composed of a single row of pores, and is supplemented by 2+2 lateral extra pore fields.

Burckhardt and Lauterer (1989) analysed the phylogenetic relationships within the Rhinocolinae. Burckhardt (1989) added a new species to the previously monotypic *Leurolophus*, redefined the genus and suggested a slightly different phylogenetic position. Here the cladistic relationships of the Rhinocolinae are re-analysed (tables 12, 13; figure 35), resulting in a single most parsimonious tree (length=21, CI=0.61, RI=0.76). The tree resembles those of Burckhardt and Lauterer (1989) and Burckhardt (1989) but differs in following points: *Leurolophus* + *Notophyllura* are placed as sister group of *Tainarys*; *Anomalopsylla* is sister group to the '*Paurocephala longicella*'—*CerATIONotum* clade rather than to *Tainarys*.

The phylogenetic analysis of *Tainarys* yielded a single most parsimonious cladogram (length = 10, CI = 0.90, RI = 0.92) (tables 14, 15; figure 36).

Table 12. Egg, larval and adult characters of the Rhinocolinae (cf. table 13, figure 35).

Egg	
1	Without (0), with apical filament (1).
Larva	
2	Claws present (0), absent (1).
3	Apical tarsal segment differentiated (0), fused with tibiotarsus (1).
Adult	
4	Antenna with 4 (0), with 6 rhinaria (1).
5	Frons broader than long (0), longer than wide (1).
6	Preocular sclerite absent (0), present (1).
7	Propleurites broad, lateral (0), narrow, lateral (1), displaced antero-ventrally (2), displaced ventrally (3).
8	Forewing with costal break (0), without (1).
9	Forewing without zig-zag pattern (0), with (1).
10	Distal portion of aedeagus without (0), with large membranous dorsal dilatation (1).
11	Valvulae dorsalis, cuneate curved (0), straight, narrow (1).

Table 13. Matrix for egg, larval and adult characters of the Rhinocolinae (table 12, figure 35); outgroup = hypothetical.

Outgroup	0000000000	<i>Megagonoscena</i>	00011000011
<i>Agonoscena</i>	00010010110	<i>Moraniella</i>	11000000000
<i>Ameroscena</i>	???10000110	<i>Notophyllura</i>	?1101121000
<i>Anomalopsylla</i>	10010000000	' <i>Paurocephala</i> ' <i>longicella</i>	00010100010
<i>Cerationotum</i>	00110010110	<i>Rhinocola</i>	00011130011
<i>Crucianus</i>	00010000110	<i>Rhusaphalara</i>	???10000010
<i>Leurolophus</i>	01101121000	<i>Tainarys</i>	?1100000000
<i>Lisronia</i>	000?0000011		

Table 14. Adult characters of *Tainarys* (cf. table 15, figure 36).

1	Female subgenital plate sparsely (0), densely setose (1).
2	Forewings with vein Rs straight or curved backwards (0), curved forwards (1).
3	Male proctiger indistinctly (0), distinctly 2-segmented (1).
4	Vein M ₁₊₂ curved backwards (0), curved forwards (1).
5	Cell M small (0), large (1).
6	Female genitalia short (0), long (1).
7	Larval antennae 8-segmented (0), 7-segmented (1).
8	Larval caudal plate truncate (0), rounded (1), angular to pointed apically (2).

Table 15. Matrix for adult characters of *Tainarys* (table 14, figure 36); outgroup = *Leurolophus oriformae*.

<i>oriformae</i>	00000000	<i>schini</i>	11110011
<i>acuticauda</i>	00001102	<i>sordida</i>	11110011
<i>inopinata</i>	000010??	<i>venata</i>	11000012
<i>maculipectus</i>	00001102		

Biogeography

Crisci *et al.* (1991a, 1991b) suggested a hybrid origin of South American biota. Northern South America was closely related to North America, and Southern South

America constituted a monophyletic group with Australia, Tasmania, New Guinea, New Caledonia and New Zealand. Though Burckhardt (1986, 1988), Burckhardt and Lauterer (1989) and Hodkinson (1989) suggested that some temperate Neotropical jumping plant-lice may belong to the latter distributional type, it has been shown since that this is not the case (e.g. Olivares and Burckhardt, 1997, for *Calinda*, or discussion below for Rhinocolinae).

Calophya is most diverse in the New World (table 1) with 39 named species (= 66.1%). The remainder of species are recorded from the Oriental and East Palaearctic Regions. There are no records of Afrotropical taxa nor of named Australian species, although *Calophya* was reported to occur in Western Australia (Taylor and Carver, 1991). An undescribed species is represented by a single ♂ from Tanzania: Arusha National Park, Ngurdoto crater rim, ca 5000 feet, 8.vi.1974 (D. Hollis) (BMNH). Two species have been introduced into other continents with their hosts (*C. rhois* and *C. schini*, table 1). The cladogram (figure 31) of *Calophya* is not sufficiently resolved for drawing biogeographic conclusions. The *luzonensis/verticornis* and *angulipennis/stigmotaeta* clades contain both New and Old World members, the *evodiae/shinjii* and *buchananiae/mangiferae* clades are Oriental/East Palaearctic and the *andina/scrobicola* clade is Neotropical.

The Rhinocolinae phylogeny, in contrast, is well documented. Burckhardt and Lauterer (1989) suggested a sister group relationship of *Tainarys* and *Anomalopsylla* implying a transantarctic relationship. Here we provide evidence for the sister group relationship of *Tainarys* with *Leurolophus* + *Notophyllura*, two predominantly Neotropical taxa. The sister group of the three genera together, *Moraniella*, is Afrotropical, a relationship which is known also from other groups of Psylloidea (e.g. *Ciriacremum*, Hollis, 1976; Hodkinson, 1989).

The mapped distributions of individual species define the following four areas of distribution (figure 37 for the *C. rubra* group):

Area A: Eastern temperate South America (Argentina (Buenos Aires, Catamarca, Cordoba, Corrientes, Misiones, Salta), W Bolivia (Santa Cruz), Brazil, Paraguay, Uruguay);

Area B: Southwest and South Andean (Chile—Regions III–X and Metropolitana, Argentina—westernmost portions of Chubut and Río Negro);

Area C: Central Argentina (Mendoza);

Area D: Northwest Andean (Peru, Northern Chile—I and II Regions, E Bolivia).

In the broadest sense, these areas agree with existing subdivisions but differ in detail. In Morrone's (1993) analysis of *Listroderes*, areas A and C are identical, area B is more restricted in the North and South and does not go into Southern Argentina, area D is absent, but there is an additional subantarctic area. Morrone *et al.* (1997) suggested that Central Chile is a composite area where the Southern portion is closer related to the subantarctic area than to the Northern portion. *Schinus* comprises only a single subantarctic species without known associated psylloid fauna. It is more diverse and widespread in the mediterranean climate-type of Chile. For this reason, Central/Southern Chile is treated here as a single, large area.

Area history

The taxon cladograms of the *Schinus* psylloids are shown in figures 33, 34, 36. By replacing the taxon names with the area in which the taxa occur, taxon area cladograms are derived (figures 38, 40, 41). By summarizing clades with terminals occupying the same area, TACs can be further simplified (figure 39).

BPA yielded for each of the three TACs a single RAC (figure 42: *C. rubra* group; figure 44: *C. hermicitae* group, *Tainarys*). All three data sets combined produced the general area cladogram in figure 43.

TASS was used to find paralogy-free subtrees, which was relevant in the case of the *Calophya rubra* group TAC. The two *Calophya* TACs have no widespread taxa and no assumptions have to be made for the translation with TAS into RACs. The resulting RACs are identical with those found with BPA (figure 42: *C. rubra* group; figure 44: *C. hermicitae* group). For *Tainarys* there is a single RAC under assumptions 0, 1 and 2 (figure 44). All three data sets combined produced the general area cladogram in figure 42 which is different from the result of BPA (figure 43).

The RACs and the combined general area cladogram derived with COMPONENT are identical with those from TAS (figure 42: *C. rubra* group; figure 44: *C. hermicitae* group, *Tainarys*).

The three methods give the same translations of TACs to RACs for all three groups but differ in the analysis of the three TACs together, where the position of area D is unstable. It is the sister group of all the remaining areas in BPA, but the sister group of area B in COMPONENT and TAS. This confirms the conclusions of Morrone and Carpenter (1994) that the three approaches may give different results.

The results from Enghoff's (1996) algorithm are the same as those found with BPA, TAS and COMPONENT (figure 42: *C. rubra* group; figure 44: *C. hermicitae* group, *Tainarys*).

The TACs in figures 45–47 provided the basis for analyses with Hovenkamp's (1997) method. The TAC in figure 45 has three TVEs (1–3), the TAC in figure 46 has two (4, 5), and the TAC in figure 47 has one TVE in each branch. The last TAC is not informative and, therefore, excluded from further analysis. Table 16 lists the nodes with the distributions of their respective descendants. Following historical information can be extracted from the diagrams in figures 48, 49: 1 > 2, 2 > 3, 1 > 2 > 3, 4 > 5. From table 16 we can combine 1 + 4 and 2 + 5 to SVEs (table 17).

Table 16. Geographical information from TACs in figures 45, 46.

Node	Areas of	
	Descendant 1	Descendant 2
1	A	BCD
2	C	BD
3	B	D
4	A	BC
5	B	C

Table 17. Supported vicariant events (SVE) in figures 48, 49.

SVE	Areas of		
	Descendant 1	Descendant 2	Supported by nodes
a	A	BCD	1, 4
b	C	BD	2, 5

The sequence of vicariance events derived from the psyllid distributions is as in figure 48. The conclusions are similar to the ones from the other analyses excepting BPA.

The three vicariance events may reflect the following geological events: (1) sea intrusion during the Tertiary separating the Eastern from the Western part of Southern South America; (2) formation of the Andes separating Chile and Peru from Central Argentina; (3) desiccation of the Atacama desert dividing Peru and Northernmost Chile from the remainder of Chile.

Even though the areas of distribution used in the study of the weevil genus *Listroderes* (Coleoptera: Curculionidae) (Morrone, 1993) differ slightly from the ones analysed here, the two scenarios can be compared. In *Listroderes*, area A is more closely related to area C, postdating the formation of the Andes. In the psyllid scenario, in contrast, it is suggested that the vicariant event happened before the formation of the Andes separating area A from all other areas together. This explanation is preliminary, as new material from many regions in temperate South America should be examined.

Taxon history

The distributional reconstructions with DIVA yielded the following results. For the *Calophya hermicitae* group there is one exact, most parsimonious solution requiring one dispersal (figure 50). The reconstruction for *Tainarys* (figure 51) yields two exact, most parsimonious solutions requiring four dispersals each. The two reconstructions differ in a single dispersal event of *T. sordida* or of *T. schini* + *T. sordida* into area B (figure 51). There are 12 most parsimonious exact reconstructions for the *Calophya rubra* group. Half of the reconstructions suggest that the group was originally restricted to the disjunct areas A and B. However, this seems unlikely. There are three reconstructions each with ancestral areas ABC and ABCD, respectively (figure 52). Without additional information it is impossible to choose one particular scenario over another.

Host plants and galls

Cospeciation

In the following cospeciation analyses we use the host tree of figure 53 and the psyllid trees of figures 33, 34, 36. None of the three psyllid trees has associations with all species of the host tree. With COMPONENT, absence was treated either as missing information or as genuine absence. Two sets of analyses had therefore to be performed. Evidence for cospeciation was found in cases where the values of the host tree were lower than the mean minus the standard deviation of 100 random trees (table 18, values in bold). The values in table 18 show almost no evidence of coevolution in the *C. rubra* group, but good evidence in the *C. hermicitae* group. In *Tainarys*, the evidence is strong if absence is treated as real, but weak when absence is treated as missing information.

Another way of optimizing the fit between host and psyllid trees is to prune each species (= leaf) and calculate the measures of fit (table 19). In the *C. rubra* group and *Tainarys*, there is one species each (*C. mammifex* and *T. sordida*, respectively) which is on several host species. Omitting them improves the tree fits. The situation in the *C. hermicitae* group is slightly different as all species are monophagous. Here a host switch of either *C. clavuligera* or *C. terebinthifolii* could be evoked.

Table 18. Measures of fit between host or 100 random trees and psyllid trees calculated with COMPONENT. Values in **bold** indicate statistical evidence for cospeciation.

	Missing information		Absent associates	
	Most tree	100 random trees, mean ± SD	Host tree	100 random trees, mean ± SD
<i>Calophya rubra</i> group				
Duplications	8		8	
Total leaves	69		76	
Leaves added	59	55.070 ± 5.186	66	70.710 ± 7.209
Min. leaves added		44		53
Max. leaves added		62		80
Losses	27	28.730 ± 4.090	28	33.410 ± 5.125
Min. losses		19		21
Max. losses		41		50
<i>Calophya hermicitae</i> group				
Duplications	1		1	
Total leaves	10		20	
Leaves added	6	12.360 ± 3.881	16	27.620 ± 8.387
Min. leaves added		4		9
Max. leaves added		16		36
Losses	3	8.420 ± 2.559	7	13.650 ± 3.529
Min. losses		3		5
Max. losses		12		22
<i>Tainarys</i>				
Duplications	3		3	
Total leaves	24		31	
Leaves added	19	22.630 ± 2.802	26	40.620 ± 4.847
Min. leaves added		19		29
Max. leaves added		25		45
Losses	5	10.430 ± 2.701	7	18.690 ± 3.656
Min. losses		5		10
Max. losses		17		29

Maps were drawn of the *Schinus* hosts and their associated psyllids with TREE MAP (figures 54–56) (Page, 1994, 1995). A randomization test was used for the evidence of cospeciation. The results (table 20) indicate that the evidence for cospeciation is strong in the *C. hermicitae* group, but absent in the *C. rubra* group and *Tainarys*. This confirms the results of the analyses with COMPONENT.

Galls

In the field and on herbarium specimens we could see that almost all *Schinus* spp. are attacked by psyllids which all induce deformations (table 21). These can be assigned to three morphological types (figure 53): (1) irregular deformations of the leaves; (2) open pit galls usually on the leaves; (3) closed galls of various shapes on the leaves, twigs and flowers. The first type is produced by members of *Tainarys* (no information available for *T. inopinata* and *T. venata*) and is restricted to species of the subgenus *Duvaua*. The other two gall types are produced by *Calophya* spp. In the *C. hermicitae* group which is associated to species of *Lithrea* and the two subgenera of *Schinus*, including the two sections of *Duvaua*, all species form pit galls. The *C. rubra* group has both pit gall and closed gall formers but the latter are

Table 19. Measures of fit after pruning 1 species (= leaf) from each psyllid tree (COMPONENT command: Prune each leaf). Absence is treated as missing information or as primitively absent. Dup. = duplications; Add. = leaves added; Los = losses; Tol. = total leaves.

Species	Missing data				Primitively absent			
	Dup.	Add.	Los.	Tol.	Dup.	Add.	Los.	Tol.
<i>Calophya rubra</i> group								
<i>andina</i>	7	53	23	62	7	60	24	69
<i>clausa</i>	7	45	23	54	7	60	26	69
<i>duvauae</i>	7	44	19	53	7	58	25	67
<i>gallifex</i>	7	52	24	61	7	58	25	67
<i>mammifex</i>	6	32	20	41	6	53	24	62
<i>orbicola</i>	7	52	24	61	7	58	25	67
<i>patagonica</i>	7	52	22	61	7	58	23	67
<i>rubra</i>	7	53	25	62	7	60	26	69
<i>schini</i>	8	42	18	51	8	45	18	54
<i>scrobicola</i>	7	52	24	61	7	58	25	67
<i>Calophya hermiticae</i> group								
<i>catillicola</i>	1	5	3	8	1	17	7	20
<i>clavuligera</i>	0	1	0	4	0	7	5	10
<i>hermiticae</i>	1	3	3	6	1	17	6	20
<i>terebinthifolii</i>	0	1	0	4	0	7	4	10
<i>Tainarys acuticauda</i>								
<i>maculipectus</i>	3	20	7	24	3	27	8	31
<i>schini</i>	3	20	7	24	3	27	9	31
<i>schini</i>	2	11	2	15	2	20	7	24
<i>sordida</i>	1	4	2	8	1	13	4	17
<i>venata</i>	2	14	5	18	2	20	7	24

Table 20. Probabilities that the number of cospeciation events is due to chance.

Taxon	Cospeciation events	Probability
<i>C. rubra</i> group	1	0.973
<i>C. hermiticae</i> group	2	0.112
<i>Tainarys</i>	1	1.000

restricted to the subgenus *Duvaua*. The closely related *Schinus latifolius* and *velutinus* do not host any pit gall formers.

It is concluded that the association of *Calophya* with *Schinus* is older than that of *Tainarys*, which colonized only the subgenus *Duvaua*. The formation of closed galls, again, postdates that of pit galls.

Conclusions

The observed psyllid diversity associated with *Schinus* cannot be explained by geographical vicariance, cospeciation or specialization on particular host organs alone, but all of these factors contribute to a certain extent. The effect of the often postulated cospeciation is surprisingly low, whereas geographical vicariance is more important than expected.

The results of our study are preliminary as many regions and hosts remain to be examined for psyllids. From a methodological point of view, there is currently

Table 21. Gall types produced by *Calophya* and *Tainarys* spp. on *Schinus* and *Lithrea* spp.

	Leaf margins irregularly rolled and crumpled	Open pit gall on leaves	Nipple or conical gall on leaves	Disk gall on leaves	Large spherical gall on leaves	Nut gall on flowers	Nut gall on twigs and branches
<i>andinus</i>							
<i>bumelioides</i>			C. sp.				
<i>engleri</i>		C. sp.	C. sp.		C. sp.		
<i>fasciculatus</i>		<i>C. catillicola</i> , C. sp.	C. <i>gallifex</i> , C. sp.	<i>C. orbicola</i>	<i>C. duvauae</i>		
<i>ferox</i>		C. sp.			C. sp.		
<i>gracilipes</i>		C. sp.	C. sp.				
<i>Johnstonii</i>							
<i>kauseli</i>							
<i>latifolius</i>			<i>C. clausa</i> <i>C. mammifex</i>				
<i>lentiscifolius</i>		C. sp.					
<i>longifolius</i>		C. sp.	2 <i>C. spp.</i>		C. sp.		
<i>marchandii</i>		C. sp.	C. sp.				
<i>meyeri</i>							
<i>molle</i>							
<i>montanus</i>							
<i>myrtifolius</i>			<i>C. schini</i>				
<i>patagonicus</i>		<i>C. acuticauda</i> , <i>T. sordida</i>	<i>C. hermicitae</i>			<i>C. floricola?</i>	
<i>plijferus</i>		<i>T. acuticauda</i> , <i>T. sordida</i>	C. sp.				
<i>polygamus</i>		<i>T. maculipectus</i> , <i>T. sordida</i> , <i>T. venata</i>	<i>C. hermicitae</i>				
<i>terebinthifolius</i>			C. sp.				
<i>velutinus</i>			<i>C. scrobicola</i>				
<i>Lithrea brasiliensis</i>						<i>C. mammifex</i>	<i>C. rubra</i>
<i>Lithrea molleoides</i>			<i>C. terebinthifolii</i>				
			<i>C. clavuligera</i> <i>C. clavuligera</i>				

no algorithm available, which can calculate most parsimonious reconstructions for a particular group, maximizing geographical vicariance, cospeciation and other events.

Acknowledgements

A substantial part of this work was carried out during the senior author's employment at the Muséum d'histoire naturelle, Geneva. DB is most grateful to his former colleagues, in particular to I. Löbl for stimulating discussions on insect systematics, to N. Lavoyer for preparing the larval drawings, to G. Roth for inking most of the other drawings and to J. Wüest for the SEM picture. The field work of DB was facilitated by many persons and institutions: cordial thanks go to CONAF for granting collecting permits for the National Parks; to the staff of the National Parks (La Campana, Conguillío, Fray Jorge, Gil de Vilches, Laguna del Laja, Nahuelbuta, Tolhuaca) for help, information and accommodation; to D. Agosti, V. Jerez and D. Lanfranco for help in the field; to the families Ballesteros-Vera, San Felipe and Nesperke-Vera, Quillota for continuous support; and to my wife Hermy for wonderful companionship on some field trips. For the loan or gift of material we thank D. Hollis (BMNH), R. J. Gill (DFAS), S. Roig (IAIM), M. Elgueta, A. Camousseight (MHNS), D. Matile (MNHN), J. Deckert (MNHU), A. Kaltenbach (NHMW), H. A. Cordo (SABC), F. Sáiz (UCVA), D. Miller (USNM), A. Baz (Madrid), P. Dale (Auckland), R. Muñoz (Santiago) and T. Olivares (Concepción). Access to herbaria was granted by R. Vickery (BMNH) and F. Jacquemoud (CJBG). Many thanks go also to P. Y. Ladiges (Melbourne), G. Nelson (New York), R. D. M. Page (Glasgow) and F. Ronquist (Uppsala) for letting us use their various software packages. Information on and identification of host plants provided by S. Roig (IAIM), F. Roig, Mendoza and J. de Dios Muñoz, Paraná. Comments by D. Hollis (BMNH) and C. J. Humphries (BMNH) greatly improved the manuscript for which we are very grateful.

References

- ANANTHAKRISHNAN, T. N. (ed.), 1984, *Biology of Gall Insects* (New Delhi, Bombay, Calcutta: Oxford and IBH Publishing Co.), 362 pp.
- ANDERSON, R. S., 1993, Weevils and plants: phylogenetic versus ecological mediation of evolution of host plant association in Curculioninae (Coleoptera: Curculionidae), *Memoirs of the Entomological Society of Canada*, **165**, 197–232.
- ARMBRUSTER, W. S., 1992, Phylogeny and the evolution of plant–animal interactions, *BioScience*, **42**, 12–20.
- BARFOD, A., 1987, 104. Anacardiaceae, in G. Harling and L. Andersson (Eds) *Flora of Ecuador*, Vol. 3, 50 pp.
- BARKLEY, F. A., 1944, *Schinus* L., *Brittonia*, **5**, 160–198.
- BARKLEY, F. A., 1957, A study of *Schinus* L., *Lilloa*, **28**, 5–110.
- BENNETT, F. D., CRESTANA, L., HABECK, D. H. and BERTI, E., 1990, Brazilian peppertree—prospects for biological control, *Proceedings of the VII International Symposium on Biological Control of Weeds*, pp. 293–297.
- BLANCHARD, E., 1852, Tribu I. Silinas, in C. Gay (ed.) *Historia Fisica y Política de Chile, Zoología*, Vol. 7 (Paris), pp. 306–316.
- BOSELLI, F. B., 1930, Studii sugli psyllidi (Homoptera: Psyllidae o Chermidae). VI. Psyllidi di Formosa raccolti dal Dr. R. Takahashi, *Bolletino del Laboratorio Zoologico, Portici*, **24**, 175–209.
- BREMER, K., 1992, Ancestral areas: a cladistic reinterpretation of the center of origin concept, *Systematic Biology*, **41**, 436–445.

- BREMER, K., 1995, Ancestral areas: optimization and probability, *Systematic Biology*, **44**, 255–259.
- BRÈTHES, J., 1920, Las agallas del Molle de incienso, *Aspiraciones*, **2**, 124–134.
- BROOKS, D. R., 1990, Parsimony analysis in historical biogeography and coevolution: methodological and theoretical update, *Systematic Zoology*, **39**, 14–30.
- BROOKS, D. R. and MCLENNAN, D. A., 1991, *Phylogeny, Ecology, and Behaviour* (Chicago: University of Chicago Press), 434 pp.
- BROWN, R. G. and HODKINSON, I. D., 1988, Taxonomy and ecology of the jumping plant-lice of Panama (Homoptera: Psylloidea), *Entomograph*, **9**, 1–304.
- BURCKHARDT, D., 1986, Biogeographie und Wirtspflanzenverhältnisse der Psylliden (Homoptera, Psylloidea) der gemässigten und subantarktischen Neotropis, *Mitteilungen der Schweizerischen entomologischen Gesellschaft*, **59**, 427–433.
- BURCKHARDT, D., 1987a, Jumping plant lice (Homoptera: Psylloidea) of the temperate neotropical region. Part 1: Psyllidae (subfamilies Aphalarinae, Rhinocolinae and Aphalaroidinae), *Zoological Journal of the Linnean Society*, **89**, 299–392.
- BURCKHARDT, D., 1987b, Jumping plant lice (Homoptera: Psylloidea) of the temperate neotropical region. Part 2: Psyllidae (subfamilies Diaphorininae, Acizzinae, Ciriacreminae and Psyllinae), *Zoological Journal of the Linnean Society*, **90**, 145–205.
- BURCKHARDT, D., 1988, Jumping plant lice (Homoptera: Psylloidea) of the temperate neotropical region. Part 3: Calophyidae and Triozidae, *Zoological Journal of the Linnean Society*, **92**, 115–191.
- BURCKHARDT, D., 1989, *Leurolophus inopinatus* sp. n. und Kladistik der Rhinocolinae (Homoptera: Psylloidea), *Revue suisse de Zoologie*, **96**, 871–875.
- BURCKHARDT, D. and LAUTERER, P., 1989, Systematics and biology of the Rhinocolinae (Homoptera: Psylloidea), *Journal of Natural History*, **23**, 643–712.
- BURCKHARDT, D. and LAUTERER, P., 1997, Systematics and biology of the *Aphalara exilis* (Weber and Mohr) species assemblage (Hemiptera: Psylloidea), *Entomologia Scandinavica*, **28**, 271–305.
- BUSH, G. L., 1975a, Modes of animal speciation, *Annual Review of Ecology and Systematics*, **6**, 339–364.
- BUSH, G. L., 1975b, Sympatric speciation in phytophagous parasitic insects, in P. W. Price (ed.) *Evolutionary Strategies of Parasitic Insects and Mites* (New York and London: Plenum Press), pp. 187–206.
- BUTLIN, R., 1988, A new approach to sympatric speciation, *Trends in Ecology and Evolution*, **2**, 310–311.
- CHESEL, D. and DOLÉDEC, S., 1992, ADE Version 3.4: HyperCard stacks and Quick Basic Microsoft Programme library for the analysis of environmental data. User's manual. Modules graphiques. Fiches pratiques. URA CNRS 1451, Université Lyon 1, Villeurbanne, France, pp. 1–130, 1–120, 1–275.
- CLARIDGE, M. F. and NIXON, G. A., 1986, *Oncopsis flavicollis* (L.) associated with tree birches (*Betula*): a complex of biological species or a host plant utilization polymorphism?, *Biological Journal of the Linnean Society*, **27**, 381–397.
- COSTA LIMA, A. da, 1942, Insetos do Brasil, Vol. 3, Chapter 23, Homópteros, *Escola nacional de Agronomia, série didáctica*, **4**, 327 pp.
- CRISCI, J. V., CIGLIANO, M. M., MORRONE, J. J. and ROIG-JUÑENT, S., 1991a, Historical biogeography of Southern South America, *Systematic Zoology*, **40**, 152–171.
- CRISCI, J. V., CIGLIANO, M. M., MORRONE, J. J. and ROIG-JUÑENT, S., 1991b, A comparative review of cladistic approaches to historical biogeography of Southern South America, *Australian Systematic Botany*, **4**, 117–126.
- DALY, H. V., 1992, A statistical and empirical evaluation of some morphometric variables of honey bee classification, in J. T. Sorensen and R. G. Foottit (eds) *Ordination in the Study of Morphology, Evolution and Systematics of Insects: Applications and Quantitative Genetic Rationals* (Amsterdam: Elsevier), pp. 127–155.
- DÍOS MUÑOS, J. de, 1990, Anacardiaceae, *Flora del Paraguay*, 84 pp.
- DOWNER, J. A., SVIHRA, P., MOLINAR, R. H., FRASER, J. B. and KOEHLER, C. S., 1988, New psyllid pest of California pepper tree, *California Agriculture*, **42**, 30–32.
- DREGER-JAUFFRET, F. and SHORTHOUSE, J. D., 1992, Diversity of gall-inducing insects and their galls, in J. D. Shorthouse and O. Rohfritsch (eds) *Biology of Insect-induced Galls* (Oxford: Oxford University Press), pp. 8–33.

- ENDERLEIN, G., 1921, Psyllidologica VI, *Zoologischer Anzeiger*, **52**, 115–122.
- ENGHOFF, H., 1996, Widespread taxa, sympatry, dispersal, and an algorithm for resolving area cladograms, *Cladistics*, **12**, 349–364.
- EWEL, J. J., 1986, Invasibility: Lessons from South Florida, in H. A. Moony and J. A. Drake (eds) Ecology of biological invasions of North America and Hawaii, *Ecological Studies*, **58**, 214–230.
- FARRIS, J. S., 1988, Hennig86, Version 1.5, Published by the author, Port Jefferson, New York.
- FLORES, E., MONTENEGRO, G. and ARGANDOÑA, V., 1989, Infección de una planta Anacardiaceae por un insecto de la Fam. Psyllidae, *XI congreso nacional de Entomología*, 15–16 November 1989, Sociedad Chilena de Entomología, Universidad de la Frontera, Temuco, p. 23.
- FLORES, E., 1990, Morphoanatomía de *Schinus polygamus* (Cav.) Cabr. (Anacardiaceae) e interacción con insectos formadores de agallas, unpublished M.Sc. thesis in Biological Sciences, Universidad de Chile, Santiago, 43 pp.
- FOOTITT, R. G. and MACKAUER, M., 1990, Morphometric variation within and between populations of the pine aphid, *Cinara nigra* (Wilson) (Homoptera: Aphidoidea: Lachnidae), in western North America, *Canadian Journal of Zoology* **68**, 1410–1419.
- GLOVER, T., 1877, Report of the Commissioner of Agriculture for the year 1876, *Agricultural Report of the United States Department of Agriculture*, 17–46.
- HAFNER, M. S. and NADLER, S. A., 1990, Cospeciation in host–parasite assemblages: comparative analysis of rates of evolution and timing of cospeciation events, *Systematic Zoology*, **39**, 192–204.
- HAMMOND, P. M., 1990, Insect abundance and diversity in the Dumoga-Bone National Park, N. Sulawesi, with special reference to the beetle fauna of a lowland rain forest in the Toraut region, in W. J. Knight and J. D. Holloway (eds) *Insects and the Rain Forests of South East Asia (Wallacea)* (London: The Royal Entomological Society of London), pp. 197–254.
- HESLOP-HARRISON, G., 1952, The genus *Rhinocola* Förster and associated genera of the Aphalarinae—I, *Annals and Magazine of Natural History*, **12**(V), 957–974.
- HIERONYMUS, G., 1884, Über seine Untersuchungen einiger Gallen, *Jahresberichte der Gesellschaft für vaterländische Cultur*, (1884), 271–272.
- HODKINSON, I. D., 1983, The psyllids (Homoptera: Psylloidea) of the Austro-Oriental, Pacific and Hawaiian zoogeographic realms: an annotated check list, *Journal of Natural History*, **17**, 341–377.
- HODKINSON, I. D., 1986, First records of Euphyllurini (Homoptera: Psylloidea) from Central and South America, *Entomologica Scandinavica*, **17**, 143–152.
- HODKINSON, I. D., 1989, The biogeography of the Neotropical jumping plant-lice (Insecta: Homoptera: Psylloidea), *Journal of Biogeography*, **16**, 203–217.
- HODKINSON, I. D. and WHITE, I. M., 1981, The Neotropical Psylloidea (Homoptera: Insecta): an annotated check list, *Journal of Natural History*, **15**, 491–523.
- HOFFMANN, A. E., 1983, El árbol urbano en Chile, *Ediciones Fundación Claudio Gay* (Santiago), 255 pp.
- HOFFMANN, A. E., 1989, Flora silvestre de Chile, zona central, *Ediciones Fundación Claudio Gay*, 2nd edn (Santiago), 255 pp.
- HOFFMANN, A. E., 1991, Flora silvestre de Chile, zona araucana, *Ediciones Fundación Claudio Gay*, 2nd edn (Santiago), 258 pp.
- HOLLIS, D., 1976, Jumping plant lice of the tribe Ciriacreminae (Homoptera: Psylloidea) in the Ethiopian Region, *Bulletin of the British Museum (Natural History)* (Entomology), **34**, 1–83.
- HOLLIS, D., 1984, Afrotropical jumping plant lice of the family Triozidae (Homoptera: Psylloidea), *Bulletin of the British Museum (Natural History)* (Entomology), **49**, 1–102.
- HOUARD, C., 1933, Les zoocécidies des plantes de l'Amérique du Sud et de l'Amérique Centrale, *Hermann and Cie Paris*, 519 pp.
- HOVENKAMP, P., 1997, Vicariance events, not areas, should be used in biogeographical analysis, *Cladistics*, **13**, 67–79.
- HUMPHRIES, C. J., COX, J. M. and NIELSEN, E. S., 1986, *Nothofagus* and its parasites: a cladistic approach to coevolution, in A. R. Stone and D. L. Hawksworth (eds) *Coevolution and Systematics, The Systematic Association special volume*, **32**, pp. 55–76.

- INTERNATIONAL CODE OF ZOOLOGICAL NOMENCLATURE (1985) 3rd edn (International Trust for Zoological Nomenclature), 338 pp.
- JESSOP, J. P., 1986, Anacardiaceae, *Flora of South Australia*, **2**, 792–793.
- JHERING, H. von, 1885, Die Galläpfel des südbrasilianischen Molho-Strauches, *Entomologische Nachrichten*, **11**, 129–132.
- JÖRGENSEN, P., 1917, Zoocecidios argentinos. *Physis, Revista de la Sociedad Argentina de Ciencias Naturales*, **3**, 1–29.
- KARSCH, F. A. F., 1880, Neue Zooecidien und Cecidozoën, *Zeitschrift für Naturwissenschaften, Berlin*, **5**, 286–309, tables vi and vii.
- KIEFFER, J. J. and HERBST, P., 1905, Über Gallen und Gallenerzeuger aus Chile, *Zeitschrift für wissenschaftliche Insektenbiologie*, **10**, 63–66.
- KIEFFER, J. J. and HERBST, P., 1906, Descriptions de galles et d'insectes gallicoles du Chili, *Annales de la Société Scientifique, Bruxelles*, **30**, 223–236.
- KIEFFER, J. J. and JÖRGENSEN, P., 1910, Gallen und Gallentiere aus Argentinien, *Zentralblatt für Bakteriologie, Parasitenkunde und Hygiene*, **2**, Abteilung **29**, 696–703.
- LEGENDRE, P. and LEGENDRE, L., 1984, *Ecologie numérique*, vols I and II (Paris: Masson).
- LEGENDRE, P. and VAUDOR, A., 1991, Le progiciel R. Analyse multidimensionnelle, analyse spatiale, Université de Montréal, Québec.
- LI, F. S., 1997, Homoptera: Psylloidea: Liviidae, Aphalaridae, Psyllidae, Calophyidae, Carsidaridae and Triozidae, *Insects of the Three Gorge Reservoir area of Yangtze River*, 351–373.
- LITTLE, E. L., 1987, *The Audubon Society Field Guide to North American Trees. Western Region*, (New York: Alfred A. Knopf), 4th printing, 640 pp.
- LIZER, C. A., 1943, Descripción de cuatro psílicos filocecidógenos, *Notas del Museo de la Plata, Zoología*, **8**, 151–165.
- LIZER, C. A. and MOLLE, C. C., 1945, Estructura anatomica de filocecidias neotropicas, *Lilloa*, **11**, 153–187.
- LÖW, F., 1879, Zur Systematik der Psylloden, *Verhandlungen der zoologisch-botanischen Gesellschaft, Wien*, **28**, 585–610.
- MABBERLEY, D. J., 1990, *The Plant-Book. A Portable Dictionary of the Higher Plants* (Cambridge: Cambridge University Press), reprinted with corrections, 707 pp.
- MADDISON, W. P. and MADDISON, D. R., 1992, *MacClade: Interactive Analysis of Phylogeny and Character Evolution. Version 3.0* (Sunderland, MA: Sinauer Associates).
- MANGANARO, A., 1914, Apuntes cecidiológicos, *Anales del Museo Nacional de Historia Natural*, **26**, 145–160.
- MANGANARO, A., 1919, Apuntes cecidiológicos, *Primera reunion nacional de la Sociedad Argentina de ciencias naturales, Tucuman, 1916, (1918/1919)*, 291–302.
- MARTINEZ-CROVETTO, R., 1963, Estudio taxonomico-biometrico de *Schinus molle* y *Schinus areira* (Anacardiaceae), *Bonplandia, Corrientes*, **1**, 225–244.
- MITTER, C., FARRELL, B. and FUTUYAMA D. J., 1991, Phylogenetic studies of insect–plant interactions: insights into the genesis of diversity, *Trends in Ecology and Evolution*, **6**, 290–293.
- MIYATAKE, Y., 1971, Studies on the Philippine Psyllidae (Hemiptera: Homoptera) I, *Bulletin of the Osaka Museum of Natural History*, **25**, 51–60.
- MORRONE, J. J., 1993, Cladistic and biogeographic analyses of the weevil genus *Listroderes* Schoenher (Coleoptera: Curculionidae), *Cladistics*, **9**, 397–411.
- MORRONE, J. J. and CARPENTER, J. M., 1994, In search of a method for cladistic biogeography: An empirical comparison of Component Analysis, Brooks Parsimony Analysis, and Three-area Statements, *Cladistics*, **10**, 99–153.
- MORRONE, J. J., KATINAS, L. and CRISCI, J. V., 1997, A cladistic biogeographical analysis of Central Chile, *Journal of Comparative Biology*, **2**, 25–42.
- MORTON, J. F., 1979, Brazilian pepper—its impact on people, animals and the environment, *Economic Botany*, **32** (1978), 353–359.
- NELSON, G. and LADIGES, P. Y., 1994, TAS—Three Area Statements: MS-DOS Program for Cladistic Biogeography, version 3.3, New York and Melbourne.
- NELSON, G. and LADIGES, P. Y., 1996, TASS: Three Area Subtrees. 2.1. MS-DOS Program, New York and Melbourne.
- NELSON, G. and PLATNICK, N. I., 1981, *Systematics and Biogeography: Cladistics and Vicariance* (New York: Columbia University Press).
- NORDLANDER, G., ZHIWEI, L. and RONQUIST, F., 1996, Phylogeny and historical biogeography of the cynipoid wasp family Ibalidae (Hymenoptera), *Systematic Entomology*, **21**, 151–166.

- NUÑEZ, C. and SAIZ, F., 1994, Cecidios en vegetación autóctona de Chile de clima mediterráneo, *Anales del Museo de Historia Natural de Valparaíso*, **22**, 57–80.
- OLIVARES, T. and BURCKHARDT, D., 1997, Jumping plant-lice of the New World genus *Calinda* (Hemiptera: Psylloidea: Triozidae), *Revue Suisse de Zoologie*, **104**, 231–344.
- OSSIANNILSSON F., 1992, The Psylloidea (Homoptera) of Fennoscandia and Denmark, *Fauna Entomologica Scandinavica*, **26**, 346 pp.
- PAGE, R. D. M., 1993, COMPONENT, version 2.0. Tree comparison software for use with Microsoft Windows. Programme and user's guide, Natural History Museum, London.
- PAGE, R. D. M., 1994, Parallel phylogenies: Reconstructing the history of host–parasite assemblages, *Cladistics*, **10**, 155–173.
- PAGE, R. D. M., 1995, TREEMAP 1.0. Programme and user's guide, published by the author, Glasgow.
- PARK, H. C., 1996, Taxonomy of Korean psyllids (Homoptera: Psylloidea). 1. A revised checklist, *Korean Journal of Entomology*, **26**, 267–278. (In Korean.)
- PARK, H. C. and LEE, C. E., 1982, Psyllids of family Aphalaridae from Korea, with descriptions of a new genus and two new species (Homoptera: Psylloidea), *Nature and Life, Kyungpook, Journal of Biological Sciences*, **12**: 13–18.
- PIMENTEL, R. A., 1992, An introduction to ordination, principal component analysis and discriminant analysis, in J. T. Sorensen and R. G. Foottit (eds) *Ordination in the Study of Morphology, Evolution and Systematics of Insects: Applications and Quantitative Genetic Rationals* (Amsterdam: Elsevier), pp. 11–28.
- PRICE, P. W., 1977, General concepts on the evolutionary biology of parasites, *Evolution*, **31**, 405–420.
- RODRÍGUEZ, R., MATTHEI, O. and QUEZADA, M., 1983, Flora arbórea de Chile, Editorial de la Universidad de Concepción, Chile, 408 pp.
- RONQUIST, F., 1995, Reconstructing the history of host–parasite associations using generalized parsimony, *Cladistics*, **11**, 73–89.
- RONQUIST, F., 1996, DIVA version 1.1, Computer program and manual available by anonymous FTP from Uppsala University (ftp.uu.se or ftp.sysbot.uu.se).
- RONQUIST, F., 1997, Dispersal-Vicariance Analysis: a new approach to the quantification of historical biogeography, *Systematic Biology*, **46**, 195–203.
- RONQUIST, F. and NYLIN S., 1990, Process and pattern in the evolution of species associations, *Systematic Zoology*, **39**, 323–344.
- RÜBSAAMEN E. H., 1899, Mitteilungen über neue und bekannte Gallen aus Europa, Asien, Afrika und Amerika, *Entomologische Nachrichten*, **25**, 225–282.
- RÜBSAAMEN E. H., 1908, Beiträge zur Kenntnis aussereuropäischer Zooecidien. III. Beitrag: Gallen aus Brasilien und Peru, *Marcellia*, **7**, 15–79.
- SÁIZ, F. and NUÑEZ, C., 1997, Estudio ecológico de las cecidias del género *Schinus*, especialmente las de hoja y de rama de *S. polygamus* y *S. latifolius* (Anacardiaceae) en Chile central, *Acta Entomologica Chilena*, **21**, 39–53.
- SCOTT, J., 1882, Description of a new genus and two new species of Psyllidae from South America, *Transactions of the Entomological Society, London*, **1982**, 443–448.
- SOUTHWOOD, T. R. E., 1978, The components of diversity, *Symposium of the Royal Entomological Society, London*, **9**, 19–40.
- STRONG, D. R., LAWTON, J. H. and SOUTHWOOD, T. R. E., 1984, *Insects on Plants, Community Patterns and Mechanisms* (Oxford: Blackwell Scientific Publications), 313 pp.
- TAUBER, C. A. and TAUBER, M. J., 1989, Sympatric speciation in insects: perception and perspective, in D. Otte and J. A. Endler (eds) *Speciation and its Consequences* (Sunderland, MA: Sinauer Associates).
- TAVARES, J. DA SILVA, 1915, Cécidologie Argentine, *Brotéria, Série Zoologique*, **13**, 88–128, plates ii–v.
- TAYLOR, K. L. and CARVER, M., 1991, Superfamily Psylloidea, in M. Carver, G. F. Gross and T. E. Woodward (eds) *Hemiptera, Insects of Australia*, 2nd edn, pp. 448–550.
- TUTHILL, L. D., 1942, *Leuolophus*, a new genus of the family Psyllidae (Homoptera), *Annals of the Entomological Society of America*, **35**, 92–93.
- TUTHILL, L. D., 1959, Los Psyllidae del Perú Central (Insecta: Homoptera), *Revista Peruana de Entomología Agrícola*, **2**, 1–27.
- TUTHILL, L. D., 1964, Conocimientos adicionales sobre los Psyllidae (Homoptera) del Perú, *Revista Peruana de Entomología*, **7**, 25–32.

- UPHOF, J. C. T., 1968, *Dictionary of Economic Plants* (Lehre: J. Cramer Publisher), 591 pp.
- WHITE, I. M. and HODKINSON, I. D., 1985, Nymphal taxonomy and systematics of the Psylloidea, *Bulletin of the British Museum (Natural History)* (Entomology), **50**, 153–301.
- WILLE, J., 1926, *Cecidoses eremita* Curt. und ihre Galle an *Schinus dependens* Ortega, *Zeitschrift für Morphologie und Ökologie der Tiere*, **7**, 1–101.
- WOOD, T. K., 1987, Host plant shift and speciation in the *Enchenopa binotata* Say complex, in M. R. Wilson and L. R. Nault (eds) *Proceedings of the 2nd International Workshop on Leafhoppers and Planthoppers of Economic Importance*, held in Provo, Utah, USA, 28 July–1 August 1986 (London: CIE), pp. 361–368.
- ZANDEE, M. and ROOS, M. C., 1987, Component compatibility in historical biogeography, *Cladistics*, **3**, 305–332.

Note added in proof

After submission of the manuscript, Li (1997) published a paper in which he synonymised *Calophya rhae* Li, 1992 with *C. verticornis* Kwon, 1992, and described following two *Calophya* spp.:

Calophya chinensis Li, 1997. China. Host plant: *Rhus chinensis* Mill. (Anacardiaceae).

Calophya melanocephala Li, 1997. China. Host plant: *Rhus chinensis* Mill. (Anacardiaceae).